

# WIRING DIAGRAM

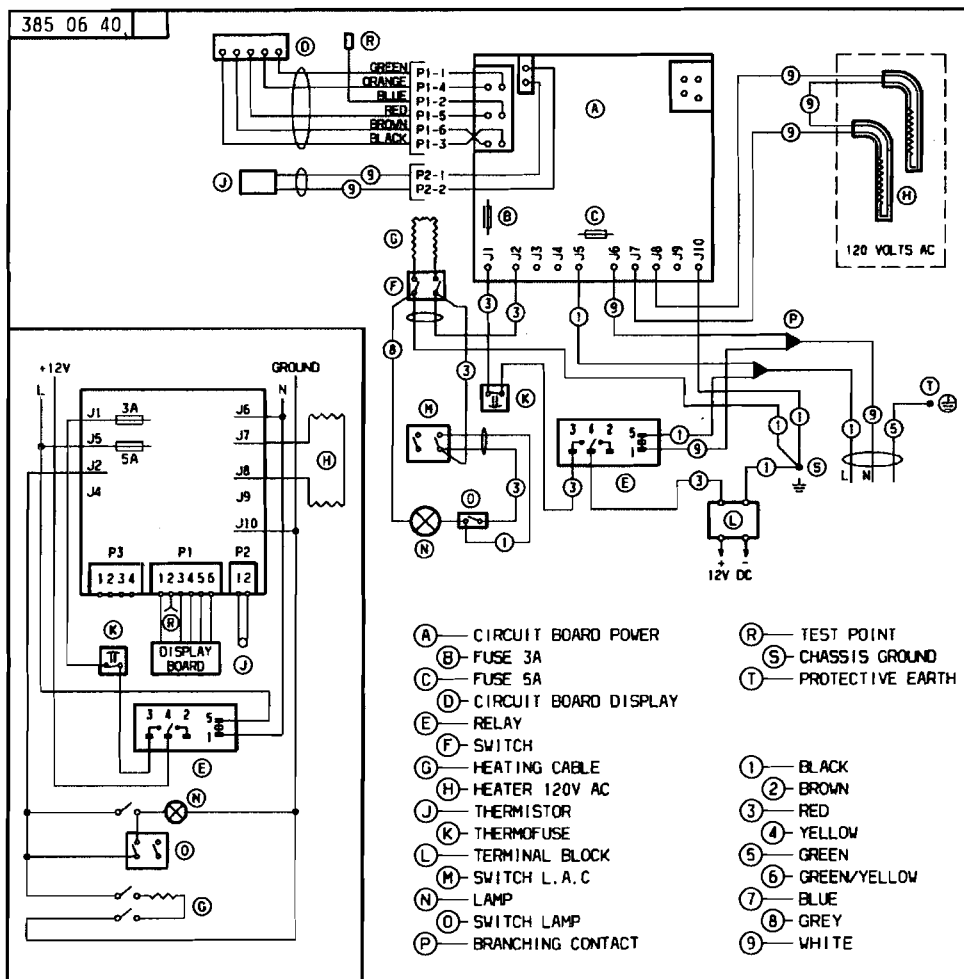

N38506400