

# WIRING DIAGRAM

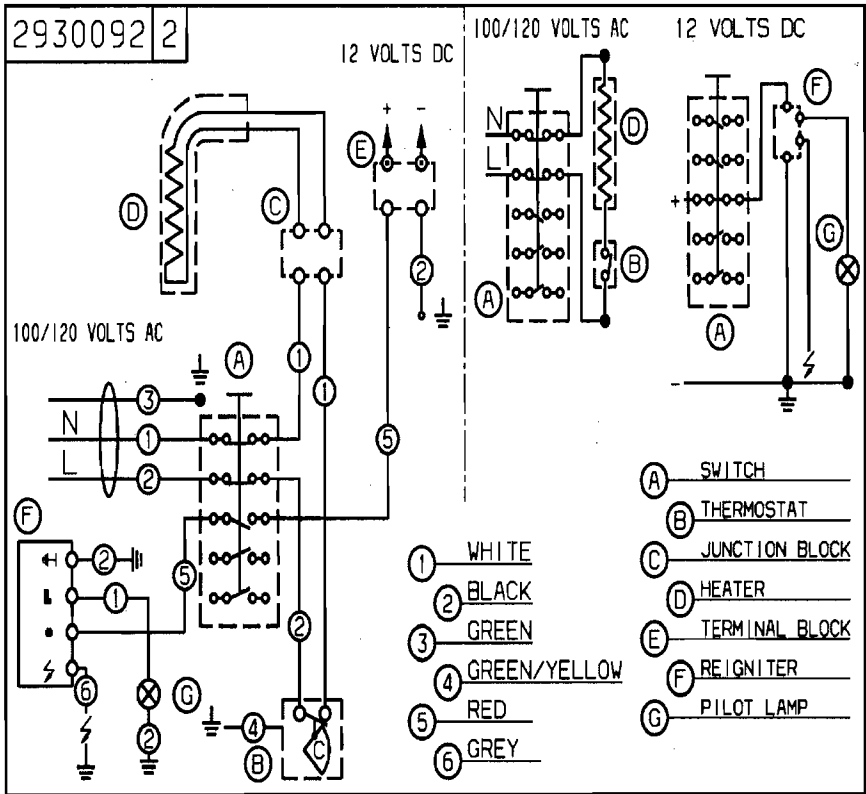

N29300922