

 Dometic®
OVER THE RANGE
MICROWAVE OVEN
INSTALLATION
INSTRUCTIONS

Please read and save these
installation instructions.

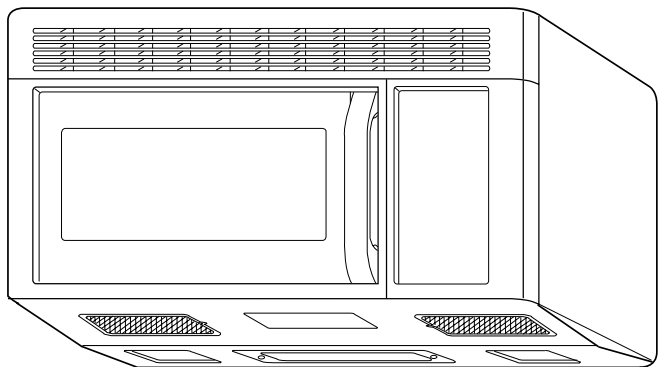

MODEL NO.: DOTRC11SS

P/N: 3828W5U0208

YOUR SAFETY FIRST

Read this entire manual before you begin.

BEFORE YOU START

- **Proper installation is the installer's responsibility!**

- Write the model & serial numbers on the owner's manual. The model number label is located on the oven front. See Figure 1. The mounting plate is located on the back side of the microwave oven. See Figure 2.

BE SURE TO READ THE FOLLOWING SAFETY INSTRUCTIONS:

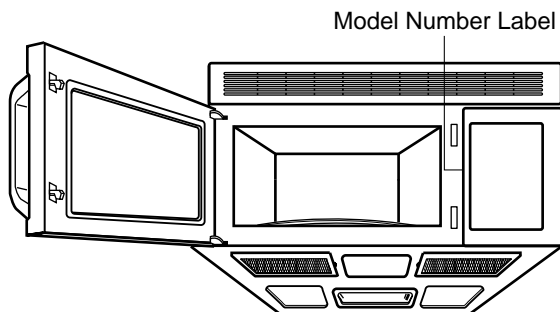

Figure 1

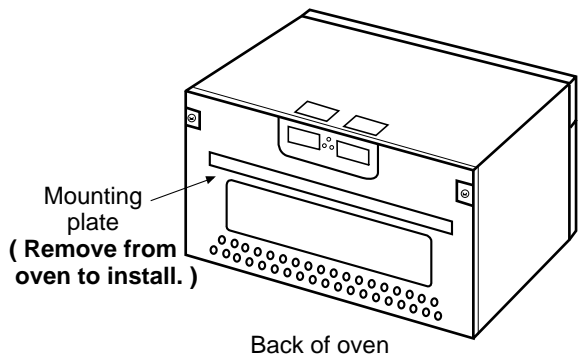

Figure 2



FOR YOUR SAFETY:

- You will need TWO people to install this oven. It is heavy and could cause personal injury if not handled properly. The dimensions of the oven are as follows:

Height : 16³/₁₆ inches
Width : 29 ⁷/₈ inches
Depth : 14 inches
Weight : 69 pounds

- **Avoid Electrical Shock!**

- Before you drill into the wall, note where electrical outlets are and where electrical wires might be concealed behind the wall. **YOU COULD GET AN ELECTRIC SHOCK** if you contact electrical wires with your drill bit.
- Locate and disconnect the power to any electrical circuits that could be affected by installing this oven. **IF YOU DO NOT DISCONNECT THE POWER, YOU COULD GET AN ELECTRIC SHOCK.**

- **ELECTRICAL RATING OF THIS OVEN : 120V AC 60Hz.**

12 A / 1300 W (Microwave oven only)

13 A / 1500 W (Microwave oven + Cooktop Lamps + Ventilation Fan)

- You need a DEDICATED 120V, 60Hz, AC only, 15 or 20A, fused electrical supply (located in the cabinet above the microwave as close as possible to the microwave) serving only the microwave.

YOUR SAFETY FIRST

• THIS APPLIANCE MUST BE GROUNDED!

– If there is an electrical short circuit, grounding reduces the risk of electrical shock by providing an escape wire for the electric current. This appliance is equipped with a cord having a grounding wire with a grounding plug.

- Place the plug into a properly installed and grounded outlet. See Figure 3.
- Do not use an extension cord.
- Keep the power cord dry and do not pinch or crush it.

• DO NOT, UNDER ANY CIRCUMSTANCES, REMOVE THE POWER SUPPLY CORD GROUNDING PRONG!

This appliance **MUST** be grounded!

PROPERLY POLARIZED AND GROUNDED OUTLET

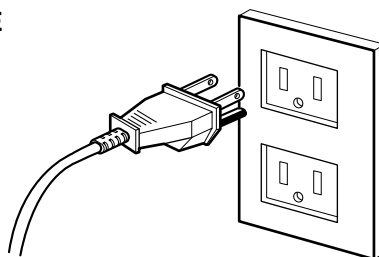

Three-Pronged (Grounding) Plug

Figure 3



WARNING

If you use the grounding plug improperly, you risk electric shock!

– Check with a qualified electrician if you are not sure whether the oven is properly grounded or if you do not completely understand the grounding instructions.

DO NOT USE A FUSE IN THE NEUTRAL OR GROUNDING CIRCUIT.



WARNING

Improper grounding could result in electric shock or other personal injury.

SAVE THESE INSTRUCTIONS FOR THE LOCAL ELECTRICAL INSPECTOR'S USE.

• DO NOT EXPOSE YOURSELF TO EXCESSIVE MICROWAVE ENERGY!

- DO NOT try to operate the microwave oven with the door open.
- DO NOT tamper with or defeat the safety interlocks.
- DO NOT place objects between the microwave oven front face and the door.
- DO NOT allow soil or cleaner residue to build up on the flat surfaces around the microwave oven door.
- DO NOT operate the microwave oven if it is damaged.
- The microwave oven door must close properly to operate safely.
- DO NOT USE THE MICROWAVE OVEN:

- If the door is bent.
- If the hinges or latches are broken or loose.
- If the door seals, sealing surfaces or glass is broken.

– DO NOT ATTEMPT TO ADJUST OR REPAIR THE OVEN YOURSELF!

It should be adjusted and repaired by a qualified technician who can check for microwave leakage after repairing the oven.



WARNING

If you do not use the microwave oven as instructed, you could be exposed to excessive microwave energy.

YOUR SAFETY FIRST

• MAKE SURE YOU HAVE ENOUGH SPACE AND SUPPORT.

- Mount the oven against a flat, vertical wall, so it is supported by the wall. The wall should be constructed to support 150 lbs.
- ATTACH AT LEAST ONE of the two lag screws supporting the oven to a vertical, frame member.
- DO NOT mount the microwave oven to an island or peninsula cabinet.
- BE SURE the upper cabinet and rear wall structures are able to support 150 lbs., plus the weight of any items you place inside the oven or upper cabinet.
- Locate the oven away from strong draft areas, such as windows, doors, and strong heating vents.
- BE SURE you have enough space. See Figure 4 below for minimum vertical and horizontal clearance.

⚠ WARNING ⚠

If you do not mount the oven as instructed,
you risk personal injury and/or property damage.

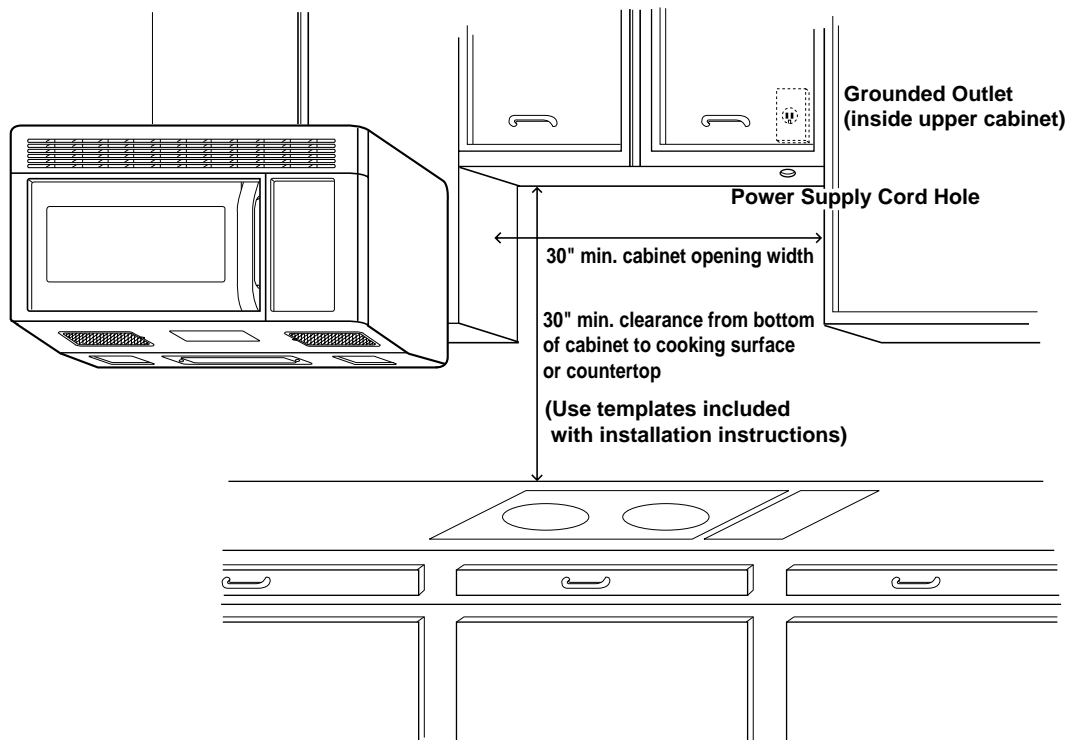

CAUTION

- Before you begin installing the oven, PLACE A PIECE OF THE CARTON OR OTHER HEAVY MATERIAL (a blanket) over the countertop or cooktop to protect it. **Do not use a plastic cover.** Failure to protect these surfaces could result in property damage.

PARTS, TOOLS, MATERIALS

THE FOLLOWING PARTS ARE SUPPLIED WITH THE OVEN:

NOTE: Depending on your ventilation requirements, you may not use all of these parts.

Backdraft damper / duct connector
(for roof-venting or wall-venting installation)
Not Actual Size (2 pieces must be
assembled as shown)

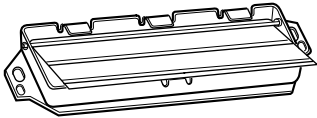

**One power cord clamp and
One dark-colored mounting screw**
(to hold the power cord)
Actual Size



Two self - tapping screws - Actual Size
(for attaching the damper duct connector)

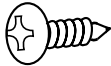

One lock pin and one washer-Not Actual size

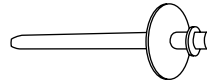

One power cord clamp bushing - Actual Size
(for the cord hole in a metal upper cabinet)

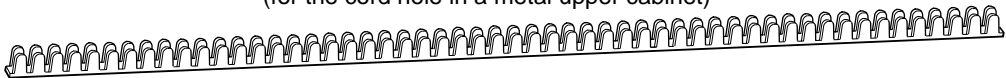

Four 1/4" x 2" lag screws - Actual Size
(for wall stud holes)

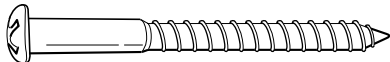

Four 1/4" x 3" toggle bolts - Actual Size
(for drywall holes)

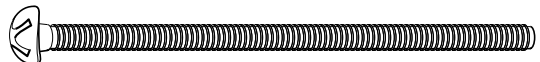

Two 1/4" x 2" bolts - Actual Size
(for securing to the upper cabinet)

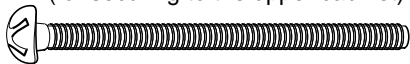

Four spring toggle heads - Actual Size
(for the toggle bolts)

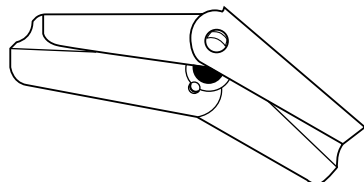

Two washers - Actual Size
(for the two upper cabinet bolts)

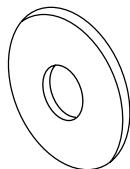

NOTE: You need to install at least one lag screw into a 2" x 4" stud and four anchor bolts into the wall.
The mounting area must meet the 150 lbs. weight requirement.

PARTS, TOOLS, MATERIALS

YOU WILL NEED THE FOLLOWING TOOLS AND MATERIALS FOR THE INSTALLATION:

Carton or other heavy material for covering the counter top.

Clear tape
(for taping the templates to the wall)



Stud finder or thin nail.

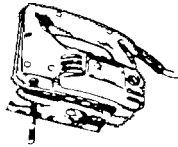

Saber saw (for cutting vent holes for roof or wall venting)

Keyhole saw (for the power cord hole)

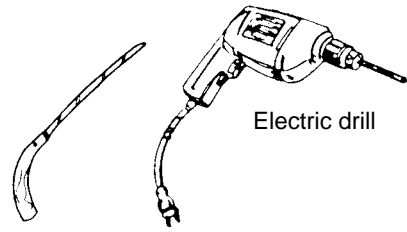

Electric drill

Phillips screwdriver (for the screws)



3/8" and 3/4" wood drill bits



Pencil

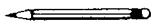

1/2" and 3/16"
drill bits

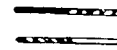

Flat blade screwdriver (for the toggle bolts)



Plumb line

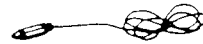

Measuring tape (metal preferred)



Duct Tape

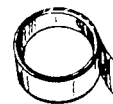

Small side cutters or tin snips



Caulking gun

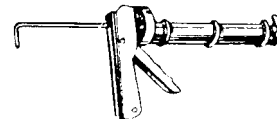

- If you have brick or masonry walls, you will need special hardware and tools.
- The ductwork you need for the installation is not included. All wall and roof caps must have a back-draft damper. (Shown on page 5.)

STEP 1: PREPARE THE ELECTRICAL CONNECTIONS



AVOID ELECTRICAL SHOCK! THIS APPLIANCE MUST BE GROUNDED!

1. Locate the grounded electric outlet for this oven in the cabinet above the oven, as shown in Figure 4.

NOTE: The outlet should be on a circuit dedicated to the microwave oven (120V, 60Hz., AC only) with a 15 or 20A fused electrical supply.

IMPORTANT: If you do not have the proper wall outlet, you **MUST** have one installed by a qualified electrician.

2. You will cut the power-supply-cord hole (shown in Figure 4) later when you prepare the wall and upper cabinet in Step 4.

NOTE: Do not use an extension cord.
Keep the power cord dry and do not pinch or crush it.

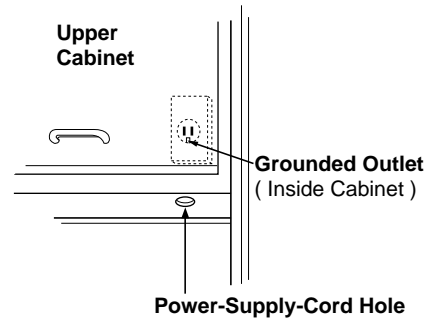

Figure 4



Improper grounding could result in electric shock or other personal injury.

- **DO NOT, UNDER ANY CIRCUMSTANCES, REMOVE THE POWER SUPPLY CORD GROUNDING PRONG!**
This appliance **MUST** be grounded!

STEP 2: PREPARE THE VENTING SYSTEM

NOTE: The ductwork you need for outside ventilation is not included with your oven. The standard ductwork fittings and length are shown in Figure 9, page 9.



WARNING - FIRE HAZARD



THIS OVEN MUST BE PROPERLY VENTED!

You may vent your oven in one of three ways. However, do NOT vent into a wall cavity, an attic, or an unused area.

Roof-venting If your oven is located on an outside wall near the roof, as in Figures 6 (3 1/4" x 10" duct) and 8 (6" round duct.)

Wall-venting If your oven is located on an outside wall of your house, as in Figure 5 (3 1/4" x 10" duct) and Figure 8 (6" round duct.)

Room-venting If your oven is located on an inside wall of your house, as in Figure 7.

NOTE: If you choose the rear exhaust method (roof-or wall-venting), be sure there is enough clearance within the wall for the exhaust duct.

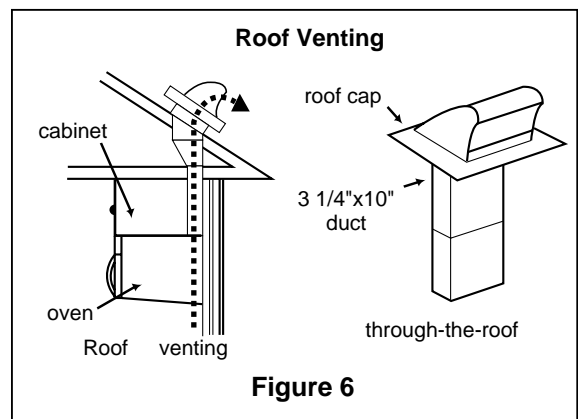
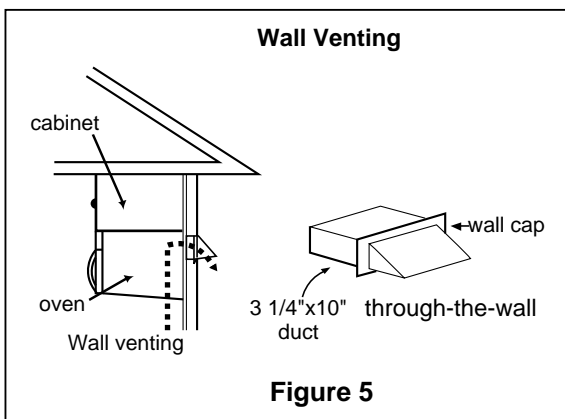

REMEMBER AS YOU INSTALL THE VENTING:

- Keep the length of the ductwork and the number of elbows to a minimum to ventilate your oven efficiently. See examples on page 9.
- Keep the size of the ductwork the same.
- Do not install two elbows together.
- Use duct tape to seal all joints in the duct system.
- Use caulking to seal the exterior wall or roof opening around the cap.

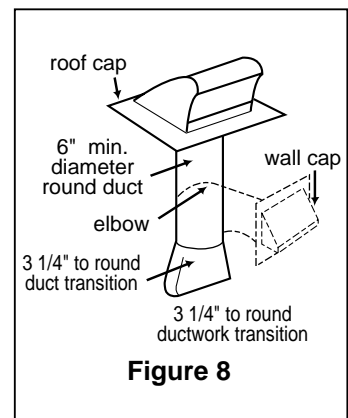
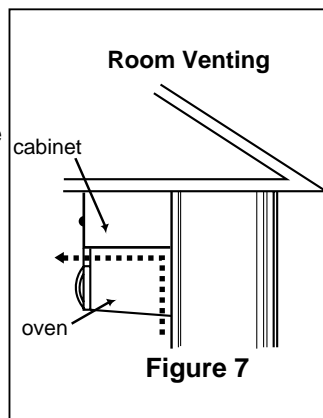

STEP 2: PREPARE THE VENTING SYSTEM

STANDARD FITTINGS

NOTE: If the existing duct is round, you must use a rectangular-to-round adapter, with a rectangular 3" extension duct installed between the damper assembly and the adapter to prevent the exhaust damper's sticking.

DUCT LENGTH

The total length of the duct system, including straight duct, elbows, transitions, and wall or roof caps **must not exceed the equivalent of 140 feet.**

For best performance, do not use more than three 90 degree elbows.

Below are the standard fittings and their equivalent length in feet.







1  3 1/4"x10" to 6"=5ft.	2  3 1/4"x10" roof cap=24ft.	3  3 1/4"x10" 90° elbow=25ft.	
4  90° elbow =10ft.	5  3 1/4"x10" wall cap =40ft.	6  45° elbow =5ft.	7  3 1/4"x10" flat elbow =10ft.

Figure 9

To calculate the equivalent length of each ductpiece used, see the examples below.

Examples	
<p>For 3 1/4"x10" SYSTEMS</p> 	<p>For 6" ROUND SYSTEMS</p> 
<p>1-3 1/4" x 10" 90° elbow = 25 ft.</p> <p>1-Wall Cap = 40 ft.</p> <p>8 feet straight duct = 8 ft.</p> <p>TOTAL LENGTH = 73 ft.</p>	<p>1-transition = 5 ft.</p> <p>2-90° elbows = 20 ft.</p> <p>1-Wall Cap = 40 ft.</p> <p>8 feet straight = 8 ft.</p> <p>TOTAL LENGTH = 73 ft.</p>

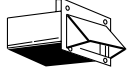
STEP 3: PREPARE THE VENTING BLOWER

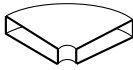
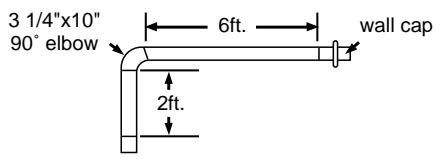
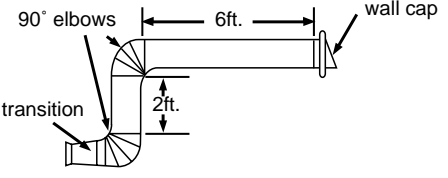
⚠ WARNING ⚠
ELECTRICAL SHOCK HAZARD!
UNPLUG UNIT BEFORE WORKING ON IT.

- DO NOT PULL OR STRETCH THE BLOWER WIRING!
Pulling and stretching the blower wiring could result in electrical shock.

Remove the two vent grille mounting screws and tip the vent grille forward, then lift it out. See Figure 10.
Loosen the two rod retainer screws behind the vent grille. See Figure 10-1, remove the wall mounting plate from the back of the oven and set aside.

WALL-VENTED INSTALLATION:

Go to STEP 4 on page 12.

ROOF-VENTED INSTALLATION:

1. Remove and save the two blower screws, See Figure 11.
2. Carefully lift the blower unit out of the microwave oven, slipping wires out of clips.
3. Rotate blower unit end over end. Rotate the unit 90° so that the exhaust ports face the upper of the unit. See Figure 12. Slip wires into clips at the bottom left hand corner of blower unit. See Figure 13.
4. Place blower unit back into cabinet. Check that the exhaust ports face the upper of the cabinet. See Figure 14.
5. Tighten the two blower screws. See Figure 14.

NOTE: If you want to install this microwave oven properly, you should be careful to tighten the blower screws. For a roof-vented installation, use the screw holes labeled "A" in figure 18 on page 11.

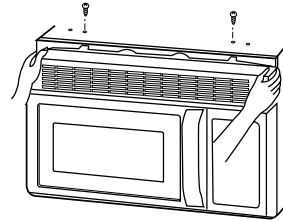

Figure 10

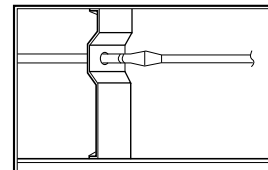

Figure 10-1

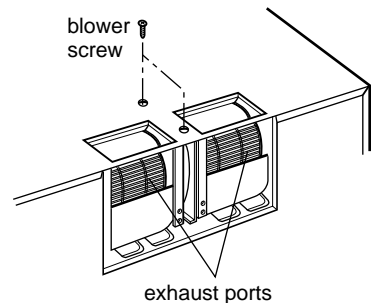

Figure 11

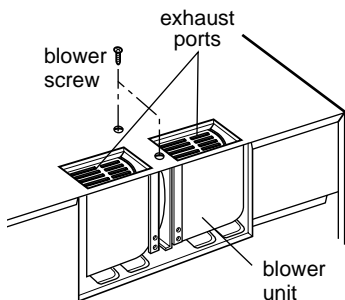

Figure 14

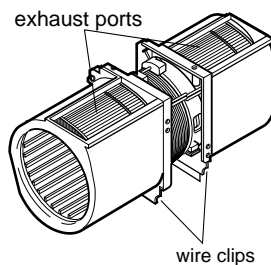

Figure 13

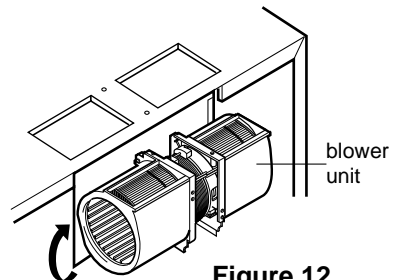

Figure 12

STEP 3: PREPARE THE VENTING BLOWER

ROOM-VENTED (recirculating) INSTALLATION:

1. Remove and save the two blower screws. See Figure 15.
2. Carefully lift the blower unit out of the microwave oven.
3. Rotate blower unit 90° turn so that the exhaust ports face the front of the unit. See Figure 16.
4. Place blower unit back into microwave oven.
5. Tighten the two blower screws. See Figure 17.

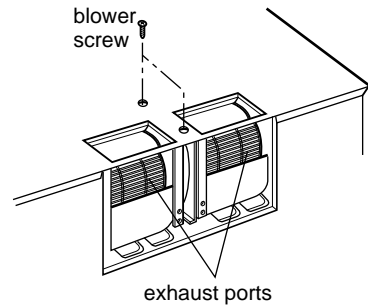

Figure 15

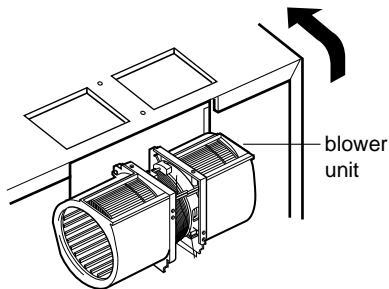

Figure 16

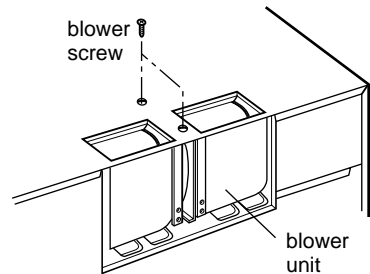

Figure 17

NOTE: If you want to install this microwave oven properly, you should be careful to tighten the blower screws. For a room-vented installation, use the screw holes labeled "C" in figure 16 below.

- : Roof-Vented installation - use "A" holes
- : Wall-Vented installation - use "B" holes
- : Room-Vented installation - use "C" holes

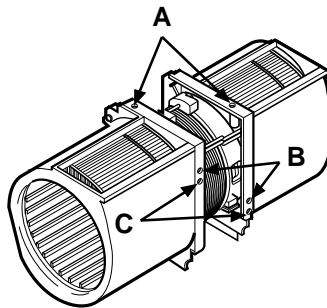

Figure 18

STEP 4: PREPARE THE WALL AND UPPER CABINET FOR INSTALLATION

BEFORE YOU START

1. Remove any shipping materials and parts from inside the microwave oven.
2. Cover the counter top or cooktop with a thick, protective covering to protect it from damage and dirt. See Figure 20.

NOTE: If you have a free-standing range, disconnect it, move it onto a piece of cardboard or hardboard and pull it away from the wall, so that you can get closer to the upper cabinet and back wall for easier measuring and drilling. Be careful not to pinch or damage the cord when you push the range back.

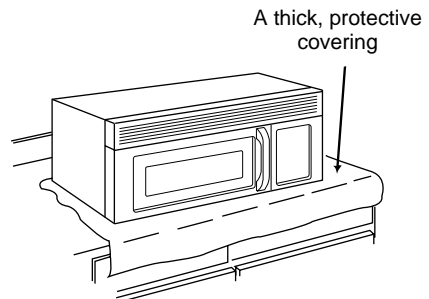

Figure 20

MEASURE AND TACK / TAPE UP THE TEMPLATES

1. Using a plumb line and (metal) measuring tape, find and mark the vertical center line on the back wall, as in Figure 21.
2. Find and mark one or two points where the studs are on the wall. (Studs are normally 16 inches apart) Then measure and mark the stud locations within the area marked **H** on the wall template. If you cannot find any wall stud, consult a local building contractor.

CAUTION

DO NOT ATTEMPT TO INSTALL THE MICROWAVE OVEN IF YOU CANNOT FIND A WALL STUD.

3. Line up the plumb line on the wall with the center line on the wall template.

NOTE: Be sure the minimum width is 30 inches and the distance from the top of the wall template to the range or counter top is at least 30 inches. See Figure 4 on page 4.

4. Securely tape or tack the wall template to the wall. See Figure 22.

NOTE: If the cabinets are not plumb, adjust the wall template to the cabinets. Remember, the oven must hang level. If the front edge of the cabinet is lower than the back edge, adjust the wall template to be level with the cabinet front.

5. Measure the bottom of the upper cabinet frame. Trim the edges **A**, **B**, and **C** on the upper cabinet template so that the template will fit on the bottom of the upper cabinet. If upper cabinet has a recessed frame, trim the template so it fits inside the recessed area. Align the centerline of the upper cabinet template with the centerline of the wall template, then securely tape or tack the upper cabinet template in place. See Figure 22.

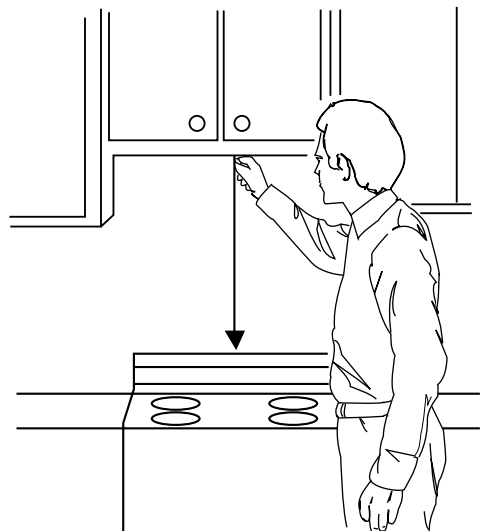

Figure 21

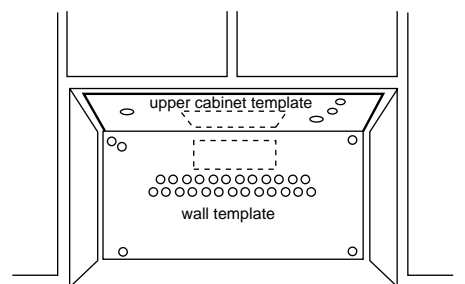

Figure 22

STEP 4: PREPARE THE WALL AND UPPER CABINET FOR INSTALLATION

DRILL THE HOLES IN THE WALL AND UPPER CABINET.



BE VERY CAREFUL WHEN DRILLING HOLES INTO THE WALL.

Electrical wires could be concealed behind the wall covering and if the drill hits them you could get an electric shock.

1. Find the points on the wall template labeled **D, E, F, and G**. Drill a 3/16" diameter hole at any points that are over a wall stud. Drill a 3/4" diameter hole at any points over drywall.
2. Locate the wall stud closest to the center of the areas marked **H and I** on the wall template. Drill 3/16" holes into the wall stud in each of the areas. If a wall stud is not located within these areas, drill 3/4" diameter holes nearest to the center of the areas as possible.
If there is not a wall stud within the areas marked H and I, or behind points marked D, E, F, and G, DO NOT install microwave oven. (Consult building inspector.) There must be at least one stud in those areas.
3. Cut or drill a **2"** diameter hole at the area marked **M**.
Power supply cord hole on the upper cabinet template. If the upper cabinet is metal, you will need to cover the edge of the hole with the power supply cord bushing (supplied) to prevent damage to the cord from the rough metal edge.



YOU MUST COVER THE EDGE OF THE POWER SUPPLY CORD HOLE IN A METAL CABINET WITH THE POWER SUPPLY CORD BUSHING. FAILURE TO DO SO COULD RESULT IN DAMAGE TO THE CORD AND ELECTRIC SHOCK.

4. Cut out the venting areas (with the saber saw):
 - Roof-Vented: cut out the shaded area marked **L** on the upper cabinet template.
 - Wall-Vented: cut out the shaded area marked **O** on the wall template.
 - Room-Vented: go to STEP 5, INSTALLING THE MOUNTING PLATE, located on page 14.
5. Complete whichever venting system you have chosen.
Use caulking compound to seal the exterior wall or roof opening around the wall cap or roof cap.

STEP 5: INSTALL THE MOUNTING PLATE

1. Remove the templates from upper cabinet and wall.

NOTE: If you are venting the oven through the wall, be sure you align the damper/connector on the rear of the mounting plate with the 3 1/4"x10" duct. Be sure the damper moves freely. See Figure 26.

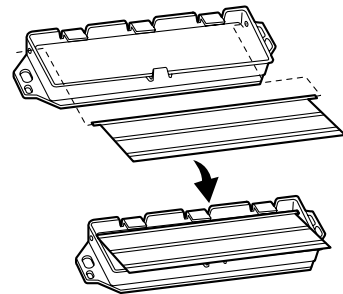

Figure 25

2. Prepare the toggle bolts by putting the bolts through the corner holes and attaching a spring toggle head to the end of each toggle bolt as shown in Figure 27.

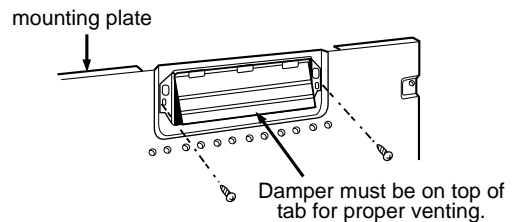

Figure 26

3. Place the mounting plate against the wall and match the screw holes. See Figure 28.

NOTE: Be sure to leave at least one wall-thickness of space between the head of the toggle bolt and the spring toggle head so that the spring toggle can open on the inside of the wall, as shown in Figure 29. You may have to pull out slightly on the bracket to put tension on the toggles.

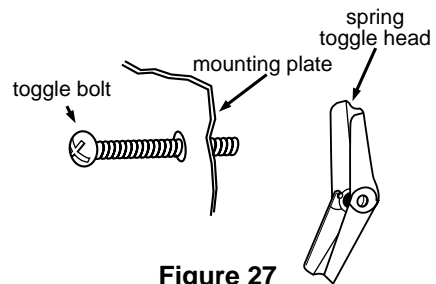

Figure 27

4. Locate the stud holes (3/16") and insert the lag screws through the mounting plate and into the holes. See Figure 30.

5. Insert the toggle bolts through the drywall holes (3/4"). Tighten the toggle bolts.

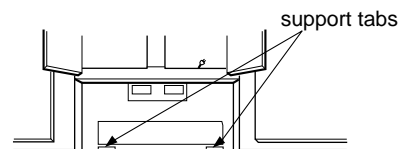

Figure 28

6. Insert a flat-blade screwdriver through the rod retainer screw clearance holes and into the mounting plate nuts in those holes. See Figure A. Move the screwdriver around to be sure the nuts move freely, as shown in Figure A. If the nuts do not move freely, the mounting plate may be too close to the wall. Loosen the toggle bolts and lag screws and adjust the mounting plate.

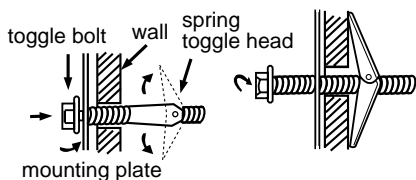

Figure 29

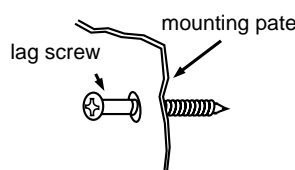

Figure 30

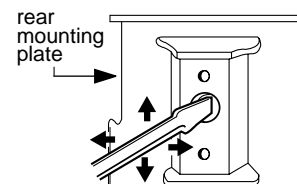

Figure A

STEP 6: ATTACH THE OVEN TO THE WALL



You will need two people to lift this microwave. Failure to use more than one person could result in personal injury.

1. Carefully lift microwave oven and hang it on support tabs (See Figure 28, page 14) at the bottom of the mounting plate. Reaching through upper cabinet, thread power supply cord through the power supply cord hole in the bottom of the upper cabinet. See Figure 31.

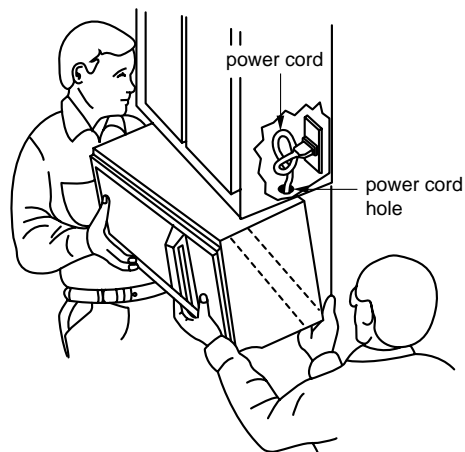

Figure 31

2. Rotate the microwave upward so the top of oven is against the bottom of the upper cabinet or cabinet frame.

3. Use a flat-blade screwdriver to push in and thread the rod retainer screws clockwise until they are tight in the mounting plate nuts, as shown in Figure 32. Try wiggling the oven to be sure it is secure.

NOTE: If the rod retainer screws will not tighten properly, loosen the front rod retainer screw brace by removing the screw at the top of the brace, as shown in Figure B. Adjust the rod retainer screws until the threads catch. Then re-attach the brace.



Figure 32

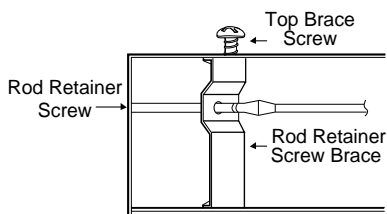

Figure B

STEP 6: ATTACH THE OVEN TO THE WALL

6. Roof-vented installation: Align the damper/duct connector with the vent on top of the microwave oven. Damper should be on top of tab. Use two tapping screws (bright-colored) to attach damper/duct connector to the microwave oven. See Figure 36.

NOTE: Damper/duct connector must be attached to microwave oven **after** microwave oven is installed.

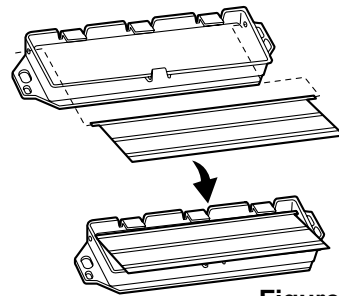

Figure 35

7. Roof venting installation: Install ductwork through the vent opening in the upper cabinet. Complete the venting system through the roof according to the method needed. See Figure 37. See PREPARE THE VENTING SYSTEM, STEP 2 on the page 8. Use caulking to seal the exterior roof opening around the exhaust cap. See Figure 6 on page 8.

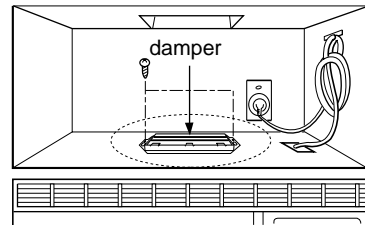

Figure 36

8. Use the power supply cord clamp to bundle the power supply cord. Install the power supply cord clamp, using a screw as shown in Figure 37, to inside of the cabinet.

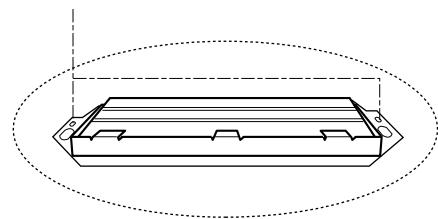

Figure 36 Detail

9. Grasp filter screen with one hand holding the ring and the other hand holding the opposite end. Insert the end of the filter screen without ring into the opening and slide towards the side of the microwave oven. Insert ring end of filter screen into the opening and slide entire screen towards the center of the microwave until screen is securely in position. Repeat for other filter screen. See Figure 38.

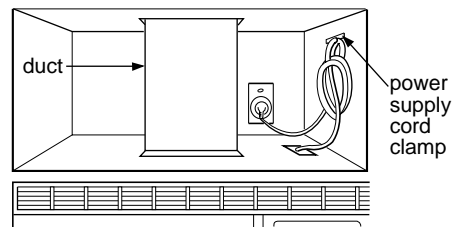

Figure 37

10. Plug in the power supply cord.

11. Read your Owner's Manual, then check the operation of your microwave oven.

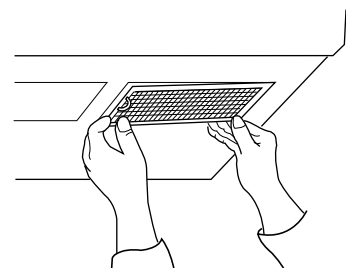

Figure 38

M

MEMO

