

# INSTALLATION/OPERATION MANUAL



## SATELLITE SYSTEM

### MODEL LP-1000

Made in U.S.A.

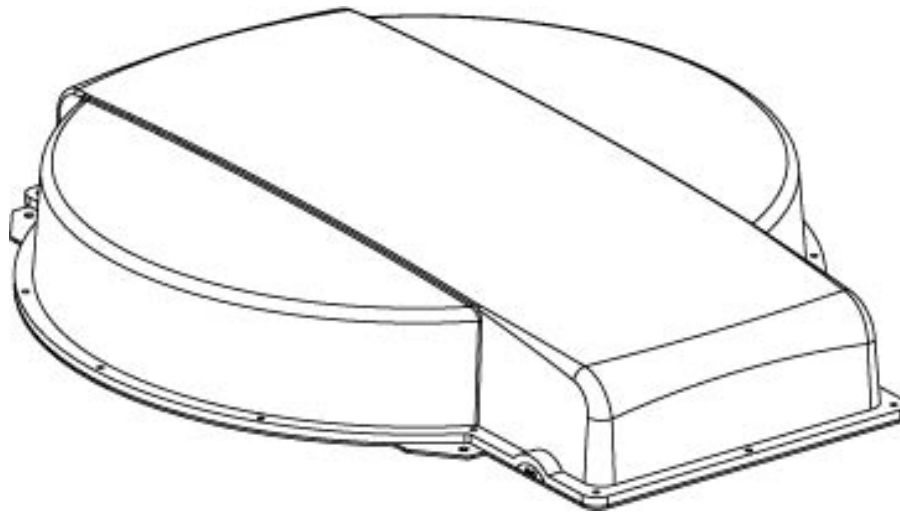

## Congratulations!

You have selected one of the most advanced and lowest profile satellite antennas available today. The Winegard RoadTrip LP antenna is a technologically advanced satellite tracking system. The RoadTrip LP is designed for use with DIRECTV<sup>®</sup> and DISH Network<sup>®</sup> satellite television providers. This manual provides important information on the installation and operation of your RoadTrip LP antenna. Please take time to read the manual before installing or operating your antenna.

**Icons appearing in the manual are used for important information and helpful tips.**



**Alert** indicates important information regarding product use, product specifications or procedures.



**Important tip** offers helpful suggestions or refers you to a related topic in the manual.

### RoadTrip LP Model Number

**LP-1000** is a satellite antenna unit designed for open road tracking and stationary use.  
**It is equipped with a single LNB for use with one satellite receiver.**

**Place RoadTrip LP serial number here**

**The serial number provided above, also located on the antenna under the radome, will be required for all troubleshooting or service calls.**

---

### Disclaimer

Although every effort has been made to insure the information in this manual is correct and complete, no company shall be held liable for any errors or omissions in this manual. All information contained in this manual is subject to change without notice. No warranty of any kind is made with regard to the information included in this manual. The RoadTrip LP antenna is designed specifically for use with motorized recreational vehicles and information contained herein is provided for that purpose only.

### Trademarks

Winegard and RoadTrip are trademarks of Winegard Company. DISH Network is a registered trademark of EchoStar Communications Corp. DIRECTV is a registered trademark of Hughes Electronics Corp. All trademarks contained in this manual are property of their respective owners. Reference made to products or services provided by companies, other than Winegard Company, does not represent any endorsement of those products or services.

<b>1. Introduction</b>	4
1.1 System Overview	4
1.2 Parts Provided with RoadTrip LP	4
1.3 Additional Equipment and Materials Required for Operation of RoadTrip LP	4
<b>2. Safety</b>	4
2.1 Installation Safety	4
2.2 Operational Safety	5
<b>3. Installation</b>	6
3.1 Installation Overview	6
3.2 Tools and Material Required for Installation	6
3.3 Unpack and Inspect Your Unit	6
3.4 Select a Location to Mount the Antenna	6-7
3.5 Mounting the Antenna	8
3.6 Adjusting Antenna Switch Settings	9
3.7 Install and Connect Cables and Wiring	10-11
<b>4. Operation</b>	12
4.1 Initial Satellite Receiver Setup	12
4.2 Stationary Operation of RoadTrip LP	12
4.3 Tracking with RoadTrip LP	13
4.4 Satellite Signal Interruption	13
<b>Appendix A</b>	
Satellite Coverage Maps and Receiver Compatability	
A.1 DISH Network	14
A.2 DIRECTV	15
<b>Appendix B</b>	
Setup and Operation of Satellite Receivers	
B.1 DISH Network	16-17
B.2 DIRECTV	18
<b>Appendix C</b> Maintenance and Troubleshooting	19
<b>Appendix D</b> Specifications and Warranty	20

# 1. INTRODUCTION

## 1.1 System Overview

The Winegard RoadTrip LP is a low profile, in-motion satellite system. RoadTrip LP utilizes GPS (global positioning system) and DVB (digital video broadcasting) technology. GPS is used to determine the present location of your antenna, and DVB is used to verify the antenna has located the correct satellite.

Roadtrip is a Ku-band satellite television reception antenna that is gyro stabilized and has a continuous 360° rotation to keep it locked on the selected satellite. RoadTrip is designed for both open-road tracking and stationary operation.



The RoadTrip system has certain operational limits with respect to use in the United States. Although designed for use with DISH Network and DIRECTV, **the system may not work in all geographical locations or with all satellite receivers. See coverage maps, pages 14 and 15.**



**Please refer to appendix A for satellite coverage maps and information on receiver compatibility.**

## 1.2 Parts Provided with RoadTrip LP

1. Antenna System (includes antenna, LNB, baseplate and control electronics) Fig 1.1
2. Radome
3. Mounting Bracket (4)
4. 35 ft. RG-6 coax with weather-protected male F-connector
5. 35 ft 2-conduct 16 AWG power wire with weather-protected connector
6. Hardware Kit (See Section 3.5 for contents)
7. Installation/Operation Manual

See page five for diagram of interior and parts

## 1.3 Additional Equipment and Materials Required for Operation of RoadTrip LP

1. Television or Video Monitor
2. Satellite Receiver with authorized programming
3. Approved sealant for roof

# 2. SAFETY

## 2.1 Installation Safety:

Winegard highly recommends the RoadTrip LP antenna system be installed by a professional installer who is familiar with satellite antenna technology and recreational vehicle wiring.

Do not attempt to install this system in the rain. Sensitive electronics may be exposed and water may also enter vehicle. Before drilling any holes for installation, make sure there are no obstructions, such as wiring, etc.

Read the entire manual before attempting to install the antenna system. Follow the instructions carefully when you begin.

Use all appropriate safety equipment, including eye protection, when installing this system.



Do not attempt to install the antenna system by yourself. Two or more people are required to lift the antenna onto the roof.



Winegard is not liable for damage, expenses, or injury caused by improper installation.

**Fig 1.1**

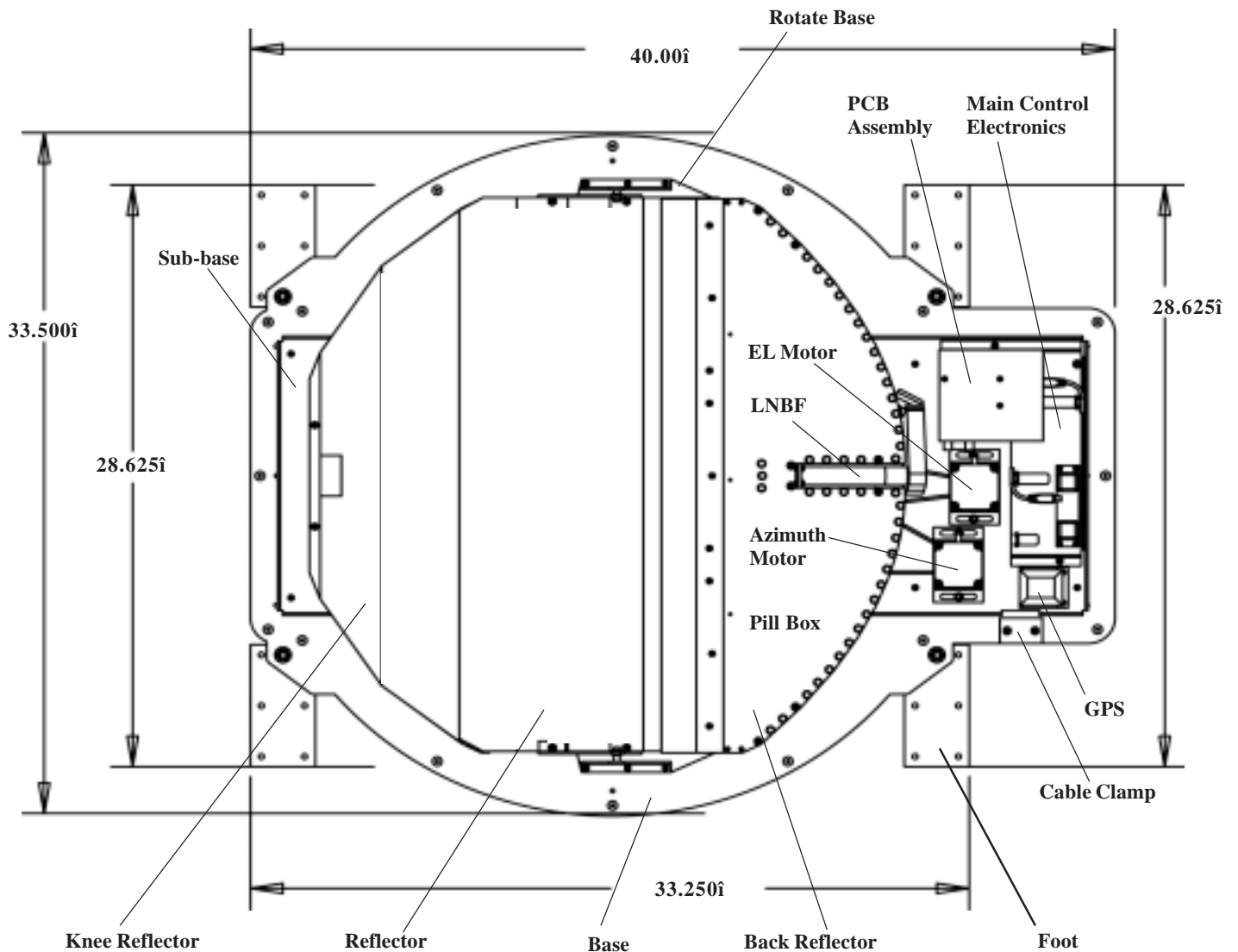

**2.2 Operational Safety:**

RoadTrip LP is capable of advanced on-road television satellite tracking. Satellite tracking systems are designed for reception of television programming while the vehicle is in motion and should only be used or operated by vehicle passengers while the vehicle is in motion.

Antenna systems and associated equipment should never be operated by the vehicle driver while vehicle is in motion.

Active television and video monitors should never be installed in view of the vehicle driver.

 **Failure of the vehicle driver to pay complete attention to the operation of the vehicle could cause an accident that might result in serious injury or death.**

### 3. INSTALLATION

#### 3.1 Installation Overview:

1. Gather the tools and materials required for installation
2. Unpack and inspect RoadTrip LP
3. Select a location to mount the antenna.
4. Mount the antenna system
5. Adjust the antenna switch settings
6. Route and connect coax and wires.

#### 3.2 Tools and Material Required for Installation:

1. Drill
2. 1/8" drill bit
3. 1" hole saw (if mounting switch in wall)
2. Tape measure
3. Wire cutter/stripper for 16 AWG wire
4. RG-6 connector crimp tool
5. RG-6 coax stripping tool
6. 7/16" open-end wrenches
7. Phillips #2 Screwdriver
8. 1/2" open-end wrench
9. Level
10. Sealant (check with RV manufacturer for proper type for your roof material)

#### 3.3 Unpack and Inspect the RoadTrip LP

When you receive your antenna, inspect for any damage that may have occurred during shipping. To safely remove the unit from the box, use two people. Open box and carefully remove the unit. The unit will be shipped with radome attached to protect the unit. RoadTrip LP will also be shipped with the mounting brackets preattached to the base. There are no shipping restraints on the antenna to remove.

#### 3.4 Select a Location to Mount the Antenna

Select level location on your roof that has a clear view of the horizon in all directions. Although the unit can be mounted up to +/- 3 degrees off level, for fastest acquisition mount the unit as close to level as possible.

The unit should be kept clear of all obstructions on the roof (air conditioning units, etc.). If you have an obstruction on the roof that may interfere with reception, use the following guidelines for determining the distance from obstruction to mount antenna.



Plan your entire installation before you start. Determine the location of all of your equipment and make sure cable and wires are long enough to reach their termination points.

**Fig 3.1**



If using a knife to open carton, **be careful not to damage the radome or cables.**

If the height of the obstruction on the roof is 6 inches, the antenna should be mounted no closer than 18 inches from the obstruction. If the obstruction is higher than 6 inches, you should add an additional 10 inches in distance for every additional 3 inches in height.

Obstruction Height	Clearance distance
6"	18"
9"	28"
12"	38"
15"	48"

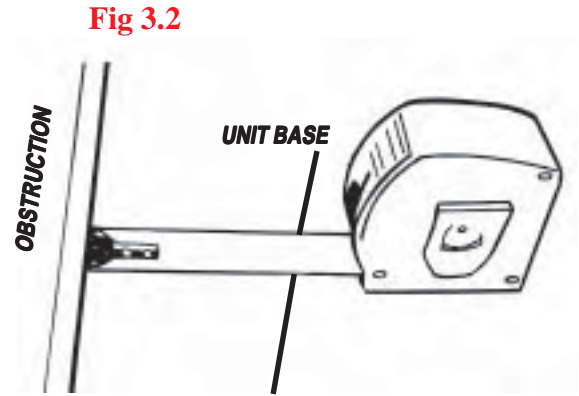

**Fig 3.2**

**Mount the antenna on the center line of the vehicle.** There are two options for mounting.

**Option A:** Point the antenna directly toward the front of the vehicle with the cables and wiring exiting the rear, driver's side, of the antenna.

**Option B:** Mount the antenna pointing directly towards the back of the vehicle with the cables and wiring exiting the front, passenger's side, of the antenna.

 The mounting option will be one of the factors used to determine the correct switch setting in Section 3.6

Refer to the following drawings of Option A and Option B.

**Fig 3.3**

**Option A**

FRONT OF VEHICLE

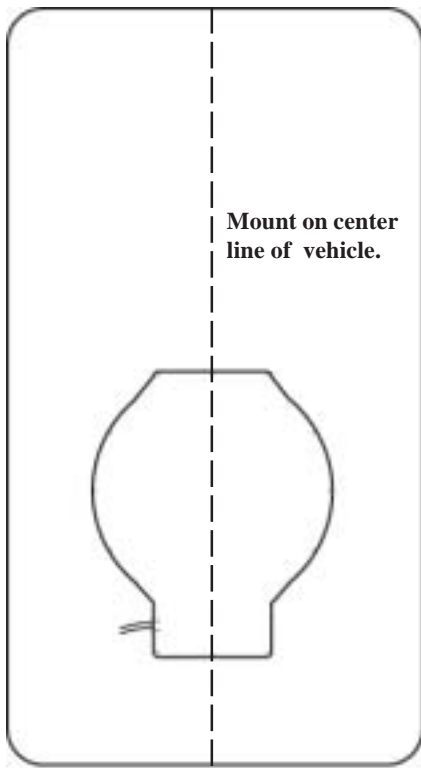

BACK OF VEHICLE

Mount on center line of vehicle.

**Fig 3.3.1**

**Option B**

FRONT OF VEHICLE

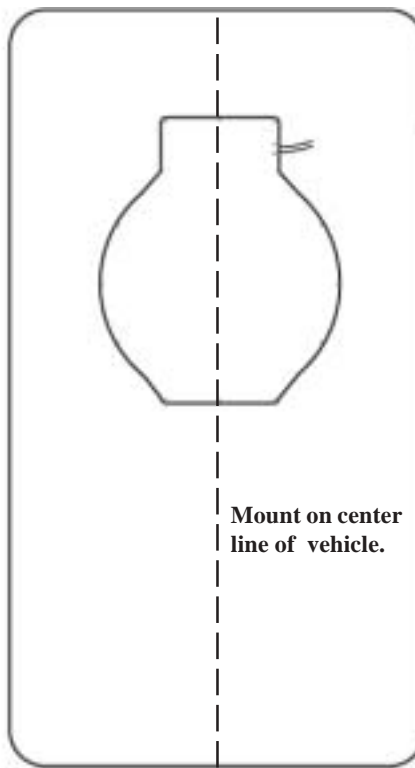

BACK OF VEHICLE

Mount on center line of vehicle.

 Failure to mount the antenna correctly may result in inferior tracking or failure to track.

### 3.5 Mounting the Antenna

#### Hardware Kit:

1. Cable ties .....2
2. Rocker switch ..... 1
3. Surface mount box screw, #6 x 1/2 .....2
4. Wallplate, surface mount screw #6-32x1, white ..2
5. Surface mount screw, #6 x 3/4, white .....2
6. RG-6 connector O-ring/gel .....2
7. Terminator, insulated 1.25-250A .....2
8. Terminator, insulated 5.5-250A ..... 1
9. Cable clamps .....2
10. Surface mount box ..... 1
11. Cable entry plate ..... 1
12. Wallplate, white ..... 1
13. Packaged screws ..... 30
14. Protective radome wipe..... 1



Hardware Kit Contents

Level the vehicle before mounting antenna.

Clean the roof area that was selected in Section 3.4. Move the antenna unit to the roof and place in permanent location.



When moving the antenna, always leave radome on to avoid damaging the antenna. Never handle the antenna unit by the cable or wiring.

**Fig 3.4**

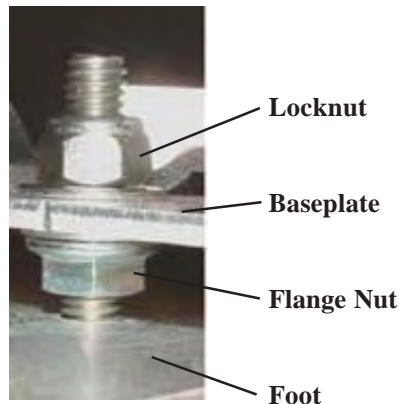

Using a level, adjust the leveling screws by tightening or loosening the flange nut under the baseplate mounting foot, **Fig 3.4**.

Remove locknut from foot, **Fig. 3.4**. Lift up baseplate, slide foot out and apply sealant to bottom of foot. Slide back into place and tighten locknut.

Screw down brackets attached to antenna using (4) # 10 screws for each bracket. After all mounting brackets are secured, add sealant on top of bracket and screws.



Be careful not get any sealant on cable or wire connectors.



### 3.6 Adjusting the Antenna Switch Settings

Depending on the satellite receiver and the mounting option selected, it may be necessary to remove the antenna radome and adjust the switch setting. **The antenna switch comes preset at the factory for mounting Option A (see Section 3.4 Fig 3.3) and for use with DirecTV receivers (see Fig 3.5).** If you have selected mounting Option B, or if you are using a DISH network receiver, remove the antenna radome and adjust the switch setting on top of the main control board (see Fig 3.6).

 Antenna switches may need to be adjusted prior to operating the system.

**Fig 3.5**  
Switches set for DirecTV mount Option A.



To adjust your antenna switch setting, remove the screws (16) that attach the radome to the base. Carefully remove the radome and set it down beside the unit. Find the Antenna Switch located on top of the main control board and adjust the switch to the appropriate setting for the mounting option and satellite receiver (See Fig 3.6).

 Refer to Section 1, Fig. 1.1, for Main Control Board location.

The position switches are numbered 1 through 8, left to right. Each switch position has a value of 1 or 0. To select the 1 value, flip the switch to the down position. To select the 0 value, flip the switch to the up position.

**Fig 3.6**

Sat. Rcvr.	Mount Option	Switch Set Position							
		1	2	3	4	5	6	7	8
DISH NETWORK	A	0	0	0	1	0	0	1	1
DISH NETWORK	B	1	0	0	1	0	0	1	1
DIRECTV	A	0	0	0	0	0	0	0	1 (FACTORY PRESET)
DIRECTV	B	1	0	0	0	0	0	0	1

**Example**  
Switches set for DISH Network, mount option A.



The antenna switch setting is very important for proper installation for your antenna. If the unit does not find the correct satellite while stationary, make sure you have the switch set for the correct satellite television provider. If the unit is operational while the vehicle is stationary, but does not track properly when in motion, make sure you have selected the appropriate switch setting for satellite television provider and proper mounting option.

### 3.7 Route and connect the coax and wires

Determine the best location for the RG-6 coax and 16 gauge power wires to enter the vehicle, and the location of the satellite receiver and rocker switch. Drill a hole in the roof for the coax and power wires to enter the vehicle. Insert the ends of the 35-foot section of RG-6 and 35-foot section of 16 gauge power wire into the hole. Be sure to insert the ends that do not have connectors on them. Push coax and power wires into the vehicle.

Using a 7/16" wrench, attach the weather-protected F-connector to the feed-through coming from the dome. First, hand-tighten the connector onto the feed-through until it seats into the rubber seal. Using one 7/16" wrench to hold the center of the feed-through, lightly tighten the F-connector to the feed-through using the other 7/16" wrench. Repeat the above step to attach F-connector on the 35-foot cable to feed-through.



**All coax connections must be tightened with a 7/16" wrench.**

**DO NOT FINGER TIGHTEN!**

**Fig 3.7**



Attach the weather-protected power connector from the antenna to the weather-protected power connector on the 35-foot section of wire. The power connector is directional. Align wire colors and firmly push connector together until latch snaps and secures.

**Fig 3.8**

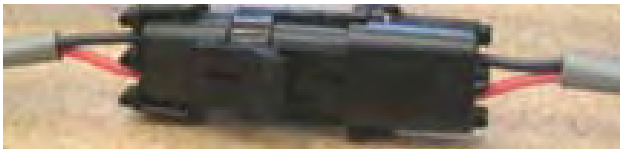

Pull remaining cable and wire into the vehicle.  
Place the cable entry plate over the hole and cables.  
Screw in place and seal plate and screws with the approved sealant. Depending on the length of the coax and wiring on the roof, it may be necessary to secure them with cable clamps. Clamping the cable every 12" to 16" should eliminate any unnecessary cable movement.

Trim coax cable if necessary and strip RG-6 coax inside the vehicle, illustration at right. Attach the provided F-connector to end of the coax and crimp connector.

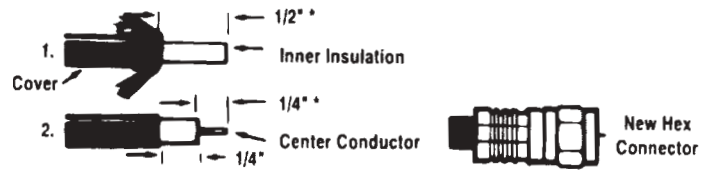

**Fig 3.9**



Connect the coax cable to the iSatellite In connection on satellite receiver, **Fig 3.9**. Follow instructions provided with your satellite receiver to connect your television.

Use wall or panel mounted power switch; drill 1" hole and pull wires through wall or panel. If using the surface mount box provided, mount box and feed wire into one of the box openings.

It is necessary to connect the power switch to a 12 VDC power source in the vehicle. Winegard recommends the 12 VDC source be wired directly to a 12 V fused source in the vehicle fuse panel. The vehicle power connection should be made last with the power switch in the iOff position.

 Do not connect the power wires to an unknown or unfused 12 volt power source. Doing so could cause improper operation and a fire hazard.

Snap the power switch into the switch plate, **Fig 3.10**.

**Fig 3.10**





Connect the ground wire from the vehicle 12 VDC power source and the antenna ground (black) wire together using the yellow spade connector. Connect the yellow spade connector to the silver spade on the power switch.

Connect the positive (red) wire from the antenna to a small red spade connector. Connect the red spade connector from the antenna to the center spade on the power switch.

Connect the positive 12V wire from the vehicle to a small red spade connector. Connect red spade connector from vehicle to the isolated spade on switch. (See **Fig 3.11** for diagram)

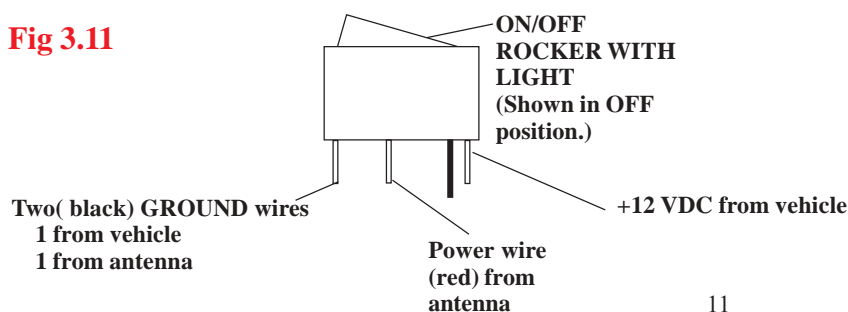
**Fig 3.11**



 If necessary you may disconnect the weather-protected connector on the roof while wiring unit. The unit is equipped with a 7.5 amp fuse located on the bottom of the Main Control Board.

## 4. OPERATION

### 4.1 Initial Satellite Receiver Setup

It is very important to set up the satellite receiver for proper antenna operation. Receiver hardware and software varies, depending on manufacturer. If you have a new receiver or you have removed your satellite receiver from the vehicle, it may be necessary to repeat the satellite receiver setup.



Refer to Appendix B for satellite receiver setups for initial and multidish operation. Follow the instructions for your satellite television provider.

### 4.2 Stationary Operation of the RoadTrip LP

After antenna has been installed and satellite receiver properly set up, operation of RoadTrip LP is easy and entirely automatic. Winegard recommends when parking your vehicle, the antenna has a clear view of the southern sky. The antenna only needs to see the required satellite(s); however, a clear view of the southern sky should improve satellite acquisition.



When using DIRECTV Receivers, you will need a clear view of the 110 satellite in addition to the DIRECTV satellite(s).

#### To Operate the RoadTrip LP:

1. Power on satellite receiver and television.
2. Power the antenna using the power switch and wait for satellite acquisition.



On initial setups, it may be necessary to set up your receiver for multidish operation (if required) after the unit has acquired the satellite and entered sleep mode. Refer to Appendix B for information on multidish setups for your satellite provider.

#### How the RoadTrip Works During Stationary Satellite Acquisition:

The reflector on the antenna will rotate clockwise until the reflector is positioned directly over the front of the vehicle.

The antenna reflector will then move to the maximum elevation to set the noise baseline for the RF detector. This is the home position for the antenna. After it is in the home position and the baseline is determined, the antenna will wait to acquire GPS information.



It is normal for your television to display the message, **!Satellite Signal Lost Searching for Signal!** while the antenna is acquiring the satellite.

After the unit has acquired GPS, it will lower the reflector to the proper elevation for a satellite search in your location. As the unit scans the proper elevation, it will locate satellite signals. The antenna will return to a scanned satellite location and verify the satellite's DVB identification. If it is the correct satellite, the antenna will peak on the signal and stop. If it is not the correct satellite, the unit will move directly to the correct satellite, stop and peak on the satellite. The unit will continue the conical scan for approximately 6 minutes. After 6 minutes, the unit will enter isleep mode and end the conical scan.

### 4.3 Tracking with the RoadTrip LP

To track with the RoadTrip, simply power on the unit using the power switch. The antenna will go through the same acquisition routines as it did while searching in the stationary mode.

If the unit was already locked on a satellite, you only need to begin moving. After the antenna unit senses forward movement, it will actively track the satellite or begin a satellite tracking search routine to find the desired satellite signal.

The antenna uses active gyros to determine vehicle movement and adjusts the antenna accordingly. Once the desired satellite is located and identified, the RoadTrip will stay actively locked on the satellite by using a conical tracking routine. If the vehicle stops while tracking, it will continue to actively track the satellite for up to 6 minutes. If the vehicle is stationary for more than 6 minutes, the unit will go into isleep mode, stop actively tracking the satellite and end the conical search.

### 4.4 Satellite Signal Interruption

Satellite TV reception systems may be disrupted by weather conditions. Satellite signals may be lost temporarily during a steady rainfall. Rain, snow or dew on the surface of the radome can adversely affect your satellite signal. It is important to maintain your radome with the approved protectant, and remove water or snow by wiping it off when necessary.

While moving, the signal can be interrupted when line-of-sight to the satellite is blocked. Tunnels, highway overpasses and dense urban areas are a few of the obstructions that may cause signal loss while in motion. If the signal is blocked for more than 15 seconds, the antenna will automatically return to a search routine.



GPS acquisition will normally take less than a minute. If you have traveled a long distance without using the antenna, acquisition may take several minutes.



If searching for the 101 DIRECTV satellite, the antenna will verify the 110 satellite prior to stopping on 101.



**The antenna will only track the satellite while moving forward. If you back your vehicle, you may lose satellite acquisition. Turning quickly when first moving may cause loss of signal.**



The antenna has an automatic peaking routine to maintain the best signal while in sleep mode or in a stationary position.



See Appendix C for periodic maintenance requirements.

## Appendix A Satellite Coverage Maps and Receiver Compatability

### A.1 DISH NETWORK

The RoadTrip LP will operate with most standard DISH Network receivers. The antenna will continually track satellite 119 and will function while stationary with satellites 119 and 110.

The RoadTrip LP will not operate with DISH Network HDTV receivers or with any DISH Network satellites other than 119 and 110.

**Winegard does not recommend using receivers with hard drives not recommended by the manufacturer for mobile applications.**

The RoadTrip will not operate in all areas satellite 119 and 110 are available. Refer to **Fig A.1.1** for an operational coverage map for Satellite 119 and 110. Satellite coverage maps are based on level, stationary operation. **When tracking with the RoadTrip, road grades, hills, on and off ramps and other inclines, may effect the operation when slope is severe, or when approaching fringe areas of operation. Reception interruption may also occur during adverse weather conditions.**

**Fig A.1.1** DISH Network satellites 119 & 110 coverage area (Area shaded in blue indicates coverage).\*

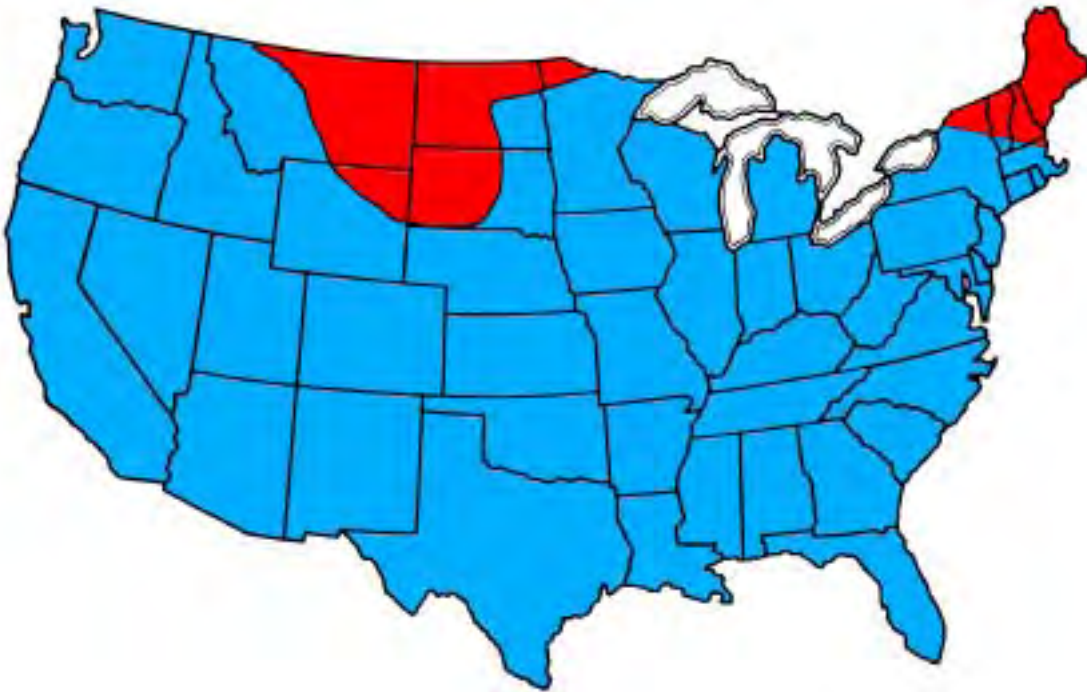

\*Coverage maps are for reference only and do not guarantee coverage.

## A.2 DIRECTV

RoadTrip LP will operate with most standard DIRECTV receivers. The antenna will continually track satellite 101 and will function while stationary with satellites 101 and 119.

RoadTrip LP will not operate with DIRECTV HDTV receivers or on any other DIRECTV satellites other than 101 and 119. **Winegard does not recommend using satellite receivers with hard drives not recommended by the manufacturer for mobile applications.**

RoadTrip will not operate in all areas satellites 101 and 119 are available. Refer to **Fig A.2.1** for an operational coverage map of satellite 101 and to **Fig A.2.2** for an operational coverage map of 119. Satellite coverage maps are based on level, stationary operation. **When tracking with the RoadTrip antenna, road grades, hills, on and off ramps and other inclines may effect the operation when slope is severe, or when approaching fringe areas of operation. Reception interruption may also occur during adverse weather conditions.**

**Fig A.2.1** DIRECTV satellite 101 RoadTrip coverage map (Area shaded in blue indicates coverage).\*

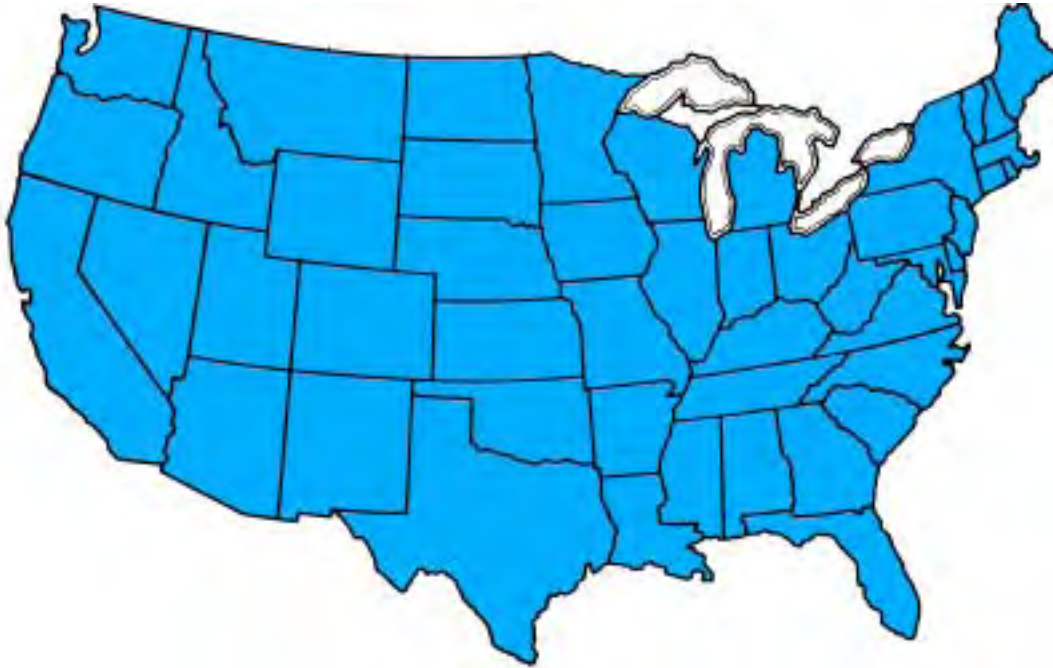

**Fig A.2.2** DIRECTV satellite 119 RoadTrip coverage map (Area shaded in blue indicates coverage).\*

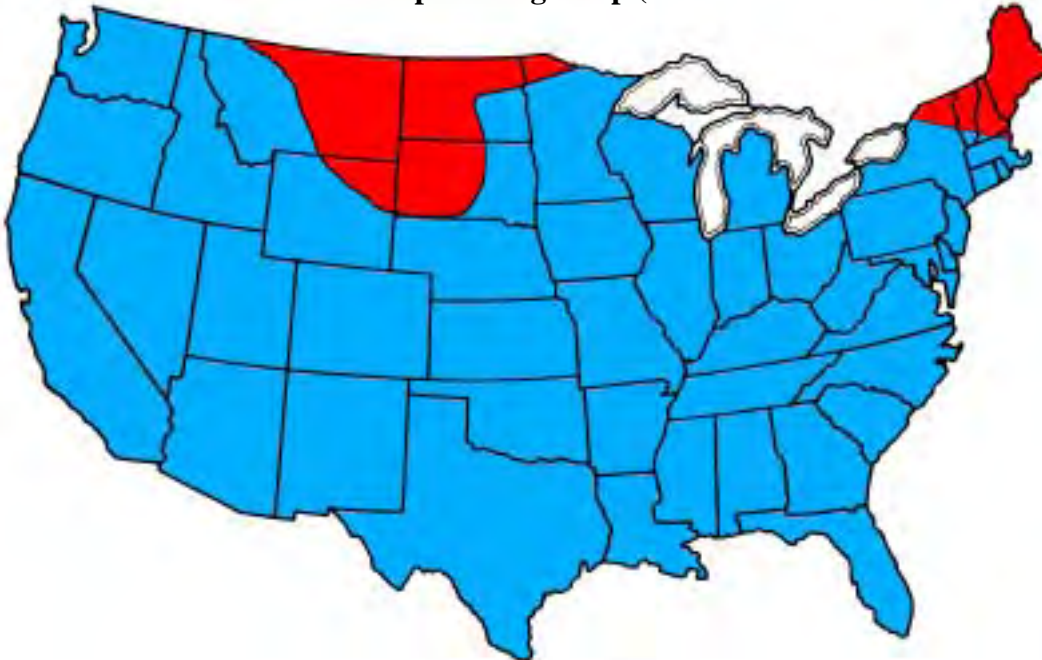

\*Coverage maps are for reference only and do not guarantee coverage.

## Appendix B Setup and Operation of Satellite Receivers

**B.1 DISH Network** (To activate your DISH Network receiver, call 1-888-ADD-DISH).

### Using your DISH Network Point Dish/Signal Screen

There are several applications where it is necessary and helpful to use the DISH Network Point Dish/Signal Screen. See **Fig B.1.1**. The following instructions will help you acquire this screen on most DISH Network receivers. You will use this screen to determine if you are locked on the correct satellite, and for Check Switch setups.

Press the iMenu button on the remote control.

Select iSystem Setup option i6i.

Select iInstallation option i1i.

Select iPoint Dish/Signal option i1i.

If you do not see a signal on your meter, be sure satellite 119 is selected and try a different transponder. All transponders may not be active.

**Fig B.1.1**

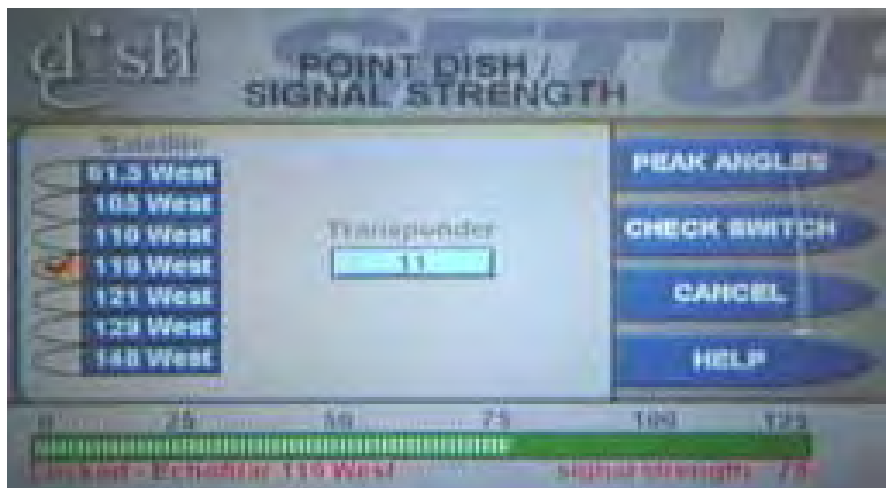

**DISH Network Point Dish/Signal Screen**

### Downloading New DISH Network Receivers

If you own or use an activated receiver that has been previously downloaded, you will not have to download the receiver.

New DISH Network receivers require downloading and program activation.

To download your receiver, follow the instructions included with your specific receiver. If you do not have a manual for your receiver, contact DISH Network or visit their website at [www.echostar.com](http://www.echostar.com). Winegard suggests downloading a new receiver on a fixed dish (such as a residential dish) whenever possible. If this not possible, you may download on the RoadTrip antenna. Connect the new receiver to the RoadTrip and turn on the system. In your iPoint Dish/Signal screen, check the box next to 119 and wait for the system to acquire the satellite. After the system has acquired the satellite and stopped the conical search, turn off the antenna. Be sure the signal strength meter indicates a strong signal on satellite 119, then continue following download instructions.



## Using your DISH Network Receiver for Multidish Operation

To set up your receiver to automatically switch from satellite 119 to satellite 110 in stationary mode, use the following instructions:

In stationary position, be sure you have a clear view of satellites 119 and 110.

Go to iPoint Dish/Signal screen and select the 119 satellite.

Turn on the RoadTrip antenna to begin search for the desired satellite.

Wait for RoadTrip to search and acquire satellite 119, end the conical search and enter iSleep mode (this will take approximately 6 minutes after 119 is found).

Using the arrow buttons on your remote, highlight the iCheck Switch box. Select iCheck Switch, then select iCheck.

The iCheck Switch will take a few minutes to complete. When complete, Installation Summary screen should show an Installed Switch of SW42 and should display information for 119 and 110, including odd and even transponders. **See Fig B.1.2.**

**Fig B.1.2**



**DISH Network Installation Summary Screen**

If the screen does not show the correct switch, repeat procedure until it is correct. After the SW42 switch is installed, you do not need to repeat this procedure unless the iCheck Switch is changed to a switch other than SW42.



You may receive an Error Message when the dish is automatically moving between satellites as you change channels. If you are prompted to run iCheck Switch, ignore this message if the switch is already set up to SW42 with 119 and 110 odd and even transponder information.

## B.2 DIRECTV (To activate your DIRECTV receiver, call 1-888-238-7177)

There are many manufacturers of DIRECTV Receivers. These instructions are for use with common menus found in most DIRECTV Receivers. If they differ from your receiver, follow instructions provided with your receiver.

### Set up your DIRECTV Receiver Dish

Select iMenuî on the remote control to access Main Menu.

Select 7 for iDish Pointingî and press OK.

Use arrow buttons and highlight iSelect Dishî and press iOKî.

Specify the oval satellite option by selecting in the iSelect Dish Antennaî screen, (Fig B.2.1). If you have an older DIRECTV receiver that does not have this option, skip this step.

Fig B.2.1

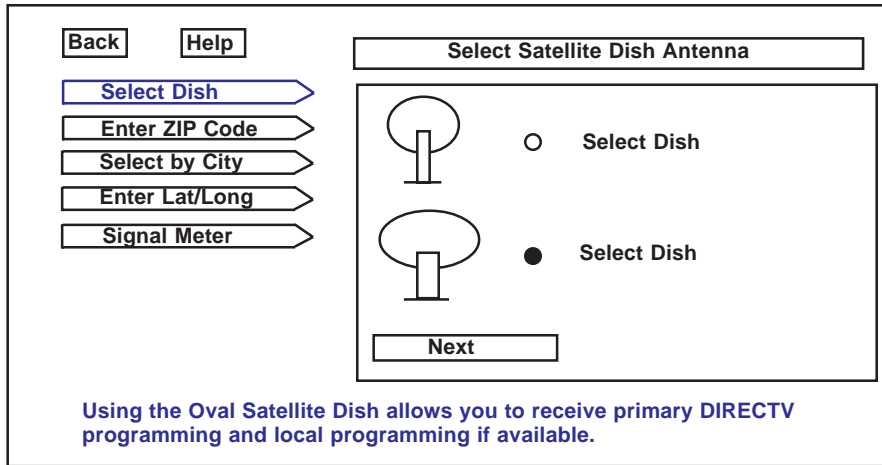

Select Dish Antenna Screen, (RCA Receiver Shown)

### Using the DIRECTV Dish Pointing Screen

The DIRECTV Dish Pointing Screen (Fig B.2.2) can be useful in determining satellite position and acquisition. The following instructions will help you access the iDish Pointing Screenî on most DIRECTV receivers.

Select iMenuî on your remote control to access the iMain Menuî.

Fig B.2.2

Select 7 for Dish Pointing, then press iOKî.

Use the arrow buttons to highlight

iSignal Meterî and press iOKî.

Select satellite i101î.

If you do not receive a signal on your meter, try another transponder. All transponders may not be active.

**Downloading New DIRECTV Receivers (If your receiver has been previously downloaded, you do not have to follow this procedure.)**

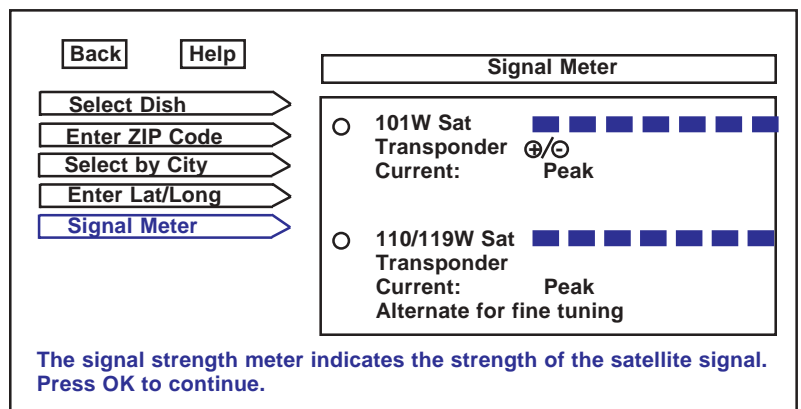

DIRECTV Dish Pointing Screen, (RCA Receiver Shown)

Some new DIRECTV Receivers may require downloading prior to use. If you need to download your receiver, Winegard recommends downloading your receiver on a fixed dish (such as a residential dish) when possible. If you cannot download your receiver on a fixed dish, connect the receiver to RoadTrip. In the iDish Pointingî screen select iSatellite 101. Turn on antenna and wait for satellite 101 to be acquired. After satellite has been acquired, wait for the unit to stop the conical search and enter iSleepî mode. Turn off the antenna. Be sure you have a signal on your signal meter. Follow the instructions provided with your receiver to complete the download.

### Using your DirecTV Receiver for MultiDish Operation

If the DIRECTV receiver is capable of MultiDish operation, there are no additional procedures to follow. The receiver will toggle between satellites automatically as long as the dish type has been properly configured to oval.

## Appendix C. Maintenance and Troubleshooting

### Maintenance

It is advisable to perform monthly maintenance on your antenna. Clean off bugs and dirt on the outside of radome using mild soap and water; treat radome with ProtectAll\*. Check fasteners on radome, antenna and antenna mounting brackets and tighten if necessary. Be sure cables and wiring are properly connected and secured.

Annual maintenance ó remove radome from antenna and clean off dirt and debris from antenna base using a clean rag. **Do not use cleaners or liquids** to clean the inside of the antenna; electronics may be damaged. Before replacing the radome, be sure all drain holes in the base are clear and free of debris.

\*ProtectAll is distributed by Protect All, Inc.,  
Anaheim, CA 92806-1215; www.protectall.com

### Troubleshooting

#### Symptom

#### Remedy

Turn on power switch and nothing happens.  
Antenna does not move.

Check for 12 VDC power at power plug on roof.  
Remove and check 7.5 amp fuse under Main Control Electronics.

Unit searches but does not lock onto  
any satellite signal.

Be sure there is an unobstructed view of desired satellite(s).  
Check for 12 VDC to 18 VDC voltage on coax cable on roof connected to Satellite In receiver connection.  
Check all coax cable and connections.  
**Tighten coax connectors with wrench, Section 3.7.**  
Be sure DirecTV receiver is set to oval dish.  
Make sure DISH receiver Check Switch has the information for desired satellite ó or is set to No Switch detected (factory default).  
Check switch settings, Section 3.6.  
Remove water or snow from radome.

Unit locks on wrong satellite.

Check switch settings, Section 3.6.

Unit works when stationary, but does not  
track satellite when moving.

Check switch settings, Section 3.6.

Unit is receiving low satellite signal strength  
that causes picture to digitize or freeze.

Check coverage maps. Pages 14-15.  
Remove water or snow from radome.

## Appendix D. Specifications and Warranty

### Specifications

Frequency Band.....	12.2 to 12.7 GHz	Height .....	61
Elevation Scan Range	..... 17 degrees to 63 degrees relative to the horizon	Weight .....	62 lbs
Azimuth Scan .....	Continous	Shipping Weight .....	78 lbs
Tracking Velocity .....	45 degrees/second	Supply Voltage.....	11.5 to 14.5 VDC
Length .....	401	Peak Current .....	5 Amps
Width .....	33-1/21	Operational Temperature	..... 25 degrees C to 70 degrees C

### TWO YEAR LIMITED WARRANTY

Winegard Company warrants this Winegard product (excluding receiver) against any defects in materials or workmanship within two (2) years from date of purchase. No warranty claim will be honored unless at the time the claim is made, you present proof of purchase to an authorized Winegard dealer (if unknown, please contact Winegard Company, 3000 Kirkwood Street, Burlington, Iowa 52601-2000, telephone 319-754-0600).

Winegard Company (at its option) will either repair or replace the defective product at no charge to you. This warranty covers parts, but does not cover any costs incurred in removal, shipping or reinstallation of the product. This limited warranty does not apply if the product is damaged, deteriorates, malfunctions or fails from: misuse, improper installation, abuse, neglect, accident, tampering, modification of the product as originally manufactured by Winegard, usage not in accordance with product instructions or acts of nature such as damage caused by wind, lightning, ice or corrosive environments such as salt spray and acid rain.

The Two Year Warranty is provided on the condition that the equipment is properly delivered with all handling and freight charges prepaid to your Winegard dealer for repair or return to our factory at the above address. Winegard dealers will arrange for the replacement or repair and return to you, without charge, the product which failed due to defective material or workmanship.

WINEGARD COMPANY WILL NOT ASSUME ANY LIABILITIES FOR ANY OTHER WARRANTIES, EXPRESS OR IMPLIED, MADE BY ANY OTHER PERSON.

ALL OTHER WARRANTIES WHETHER EXPRESS, IMPLIED OR STATUTORY INCLUDING WARRANTIES OF FITNESS FOR A PARTICULAR PURPOSE AND MERCHANTABILITY ARE LIMITED TO THE TWO YEAR PERIOD OF THIS WRITTEN WARRANTY.

The foregoing shall be the sole and exclusive remedy of any person whether in contract, tort or otherwise, and Winegard shall not be liable for incidental or consequential damage or commercial loss, or from any other loss or damage except as set forth above.

Some states do not allow limitations on how long an implied warranty lasts, or the exclusion of limitation of incidental or consequential damages, so the above limitations or exclusions may not apply to you.

This warranty gives you specific legal rights and you may also have other rights which vary from state to state.

### Warranty Procedure

Please contact your local dealer or installer if you have a problem with your unit.

Any parts or products that are to be returned to Winegard Company must have prior approval.

Contact Winegard Technical Services at 1-800-788-4417 for a Return Authorization. Be sure to have your unit serial number available when contacting Winegard Technical Services.

### For Winegard warranty information:

Att: Technical Services  
Winegard Company  
3000 Kirkwood St.  
Burlington, IA 52601-2000  
800-788-4417  
Fax: 1-319-754-0787

