

# 500629 & 140-1226 Automatic Touchpad

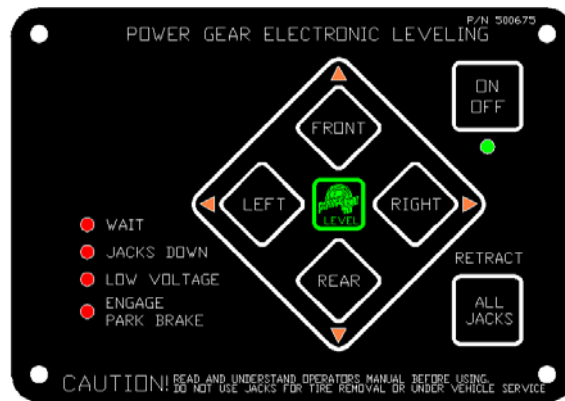

# 500675 & 140-1231 Semi-Auto Touchpad

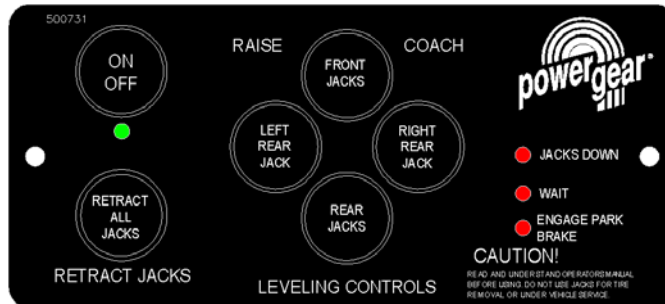

# 500731 Manual Touchpad

***Parts and Service Manual for Hydraulic Leveling Systems with Touch Pad Part Numbers 500675, 140-1231, 500629, 140-1226, and 500731 with Spring Return Jacks.***

Thank you for buying our Power Gear product! Before servicing this leveling system read this manual carefully and pay attention to the "notes" and "warnings". Remember that all leveling systems can be dangerous if used improperly. Also keep in mind safety, and use the leveling system in accordance with the operating instruction manual and common sense. This manual has been prepared for the service of the spring return jacks leveling system. Its purpose, aside from recommending standard service procedures and routine service requirements, is to promote safety through the use of accepted service practices. Read, understand and follow the safety instructions and notes of this manual and all safety messages on the components. It is recommended that all users of this equipment become familiar with the controls, components, and operation of this product before servicing the leveling system. Study this manual before servicing or operating, and keep it handy for future reference.

## **TABLE OF CONTENTS**

<b>Page 2:</b>	<b>Table of Contents</b>
<b>Page 3:</b>	<b>Warning/Before You Service the Coach</b>
<b>Page 4:</b>	<b>System Description</b>
<b>Page 5:</b>	<b>Recommended Fluids/Preventive Maintenance</b>
<b>Page 6:</b>	<b>General Operation Instructions</b>
<b>Page 7-9:</b>	<b>Metal Tank Hydraulic Pump Assemblies</b>
<b>Page 10-11:</b>	<b>Plastic Tank Hydraulic Pump Assemblies</b>
<b>Page 12:</b>	<b>Hose Identification Guide</b>
<b>Page 13:</b>	<b>Hydraulic Fittings</b>
<b>Page 14-19:</b>	<b>Touch Pad and Control Box Connections</b>
<b>Page 20-21:</b>	<b>Wiring Diagrams</b>
<b>Page 22-28:</b>	<b>Troubleshooting Guide</b>

# **BEFORE YOU SERVICE THE COACH**

## **WARNING**

- **DO NOT USE THE POWER GEAR HYDRAULIC LEVELING SYSTEM (OR AIR SUSPENSION) TO SUPPORT VEHICLE WHILE UNDER COACH OR CHANGING TIRES. THE HYDRAULIC LEVELING SYSTEM IS DESIGNED AS A 'LEVELING' SYSTEM ONLY. TIRE REPAIRS SHOULD BE PERFORMED BY A TRAINED PROFESSIONAL. ATTEMPTS TO CHANGE TIRES WHILE SUPPORTING THE VEHICLE WITH THE HYDRAULIC SYSTEM COULD RESULT IN DAMAGE TO THE MOTOR HOME AND/OR CAUSE SERIOUS INJURY OR EVEN DEATH.**
- **KEEP PEOPLE CLEAR OF COACH WHILE LEVELING SYSTEM IS IN USE.**
- **NEVER LIFT THE WHEELS OFF THE GROUND TO LEVEL THE COACH. DOING SO MAY CREATE AN UNSTABLE CONDITION.**
- **NEVER EXPOSE HANDS OR OTHER PARTS OF THE BODY NEAR HYDRAULIC LEAKS. HIGH PRESSURE OIL LEAKS MAY CUT AND PENETRATE THE SKIN CAUSING SERIOUS INJURY.**
- **DO NOT USE A HIGH PRESSURED WASH/RINSE SYSTEM ON ANY OF THE COMPONENTS ASSOCIATED WITH THE LEVELING SYSTEM. THIS INCLUDES THE PUMP, PUMP MOTOR, WIRING HARNESS, CONTROL, AND TOUCHPAD. THE USE OF A HIGH PRESSURE WASH/RINSE SYSTEM WILL VOID THE WARRANTY.**

**CAUTION - PARK THE COACH ON A REASONABLY SOLID SURFACE OR THE JACKS MAY SINK INTO GROUND. ON SOFT SURFACES, USE LOAD DISTRIBUTION PADS UNDER EACH JACK.**

**CAUTION - CHECK THAT POTENTIAL JACK CONTACT LOCATIONS ARE CLEAR OF OBSTRUCTIONS OR DEPRESSIONS BEFORE OPERATION.**

## **BEFORE YOU OPERATE THE SYSTEM:**

1. Make sure jack cylinder paths from the coach to the ground are clear and free of obstructions.
2. Make sure that the coach does not have objects leaning against the sides of it. As the coach will rise when the jack cylinders engage the ground and start to lift, moving the coach.
3. Place blocks under the jack cylinder foot pads for soft or low ground issues. Use as many blocks as needed to bring the depression, equal to or above the surrounding ground level.

# MAJOR COMPONENT DESCRIPTION

**SYSTEM DESCRIPTION** - The Power Gear electro-hydraulic leveling system consists of the following major components:

**(A) Touch Pad** that is located inside the cab area of the coach. The touch pad communicates the input functions to the control box and receives status signals from the control. The available touch pads are:

- Manual touch pad (Part # 500731). Does not use a separate control box.
- Semi-Automatic touch pad (Part #'s 500675 or 140-1231). These use a separate control box.
- Automatic touch pad (Part #'s 500629 or 140-1226). These use a separate control box.

**(B) Control Box** which has an internal leveling sensor and levels the coach to a calibrated point; it is mounted upside down inside a water proof location in the center of the coach. Contact the O.E.M for exact location. The control box communicates with the hydraulic pump assembly and the touch pad. A new or replacement control box does not have a stored level point; this must be set after installation. See reference documents for calibration procedure. The available control boxes are:

- Semi-Automatic control box (Part #'s 500674 or 140-1230).
- Automatic control box (Part #'s 500630, 140-1227, 1010001284, 1010001002 and 9010000156).

**(C) Hydraulic Pump Assembly** that consists of these components: motor, motor starter solenoid, pump, reservoir tank and manifold assembly. The manifold assembly has leg valve assemblies and a dump valve assembly. There is a manual override leg or dump valve with a trailer style connector or a packard style connector. There is also a non-override leg or dump valve with a trailer style connector or a packard style connector.

**(D) Hydraulic Hoses** are used to connect the hydraulic pump assembly to the jack leg cylinders. The hoses are rated according to the output pressure of the pump assembly.

**(E) Jack Leg Cylinders** with either internal or external springs that are rated at a lifting capacity appropriate for your coach. Each jack has a large 10" diameter (78.5 square inch) shoe for maximum mating area on different surfaces. External spring jacks have a spring that is mounted externally and connected both to the top at the jack bracket and to the shoe of the jack. Internal spring jacks have a spring welded to the inside top of the jack and connected to the top of the chrome rod.

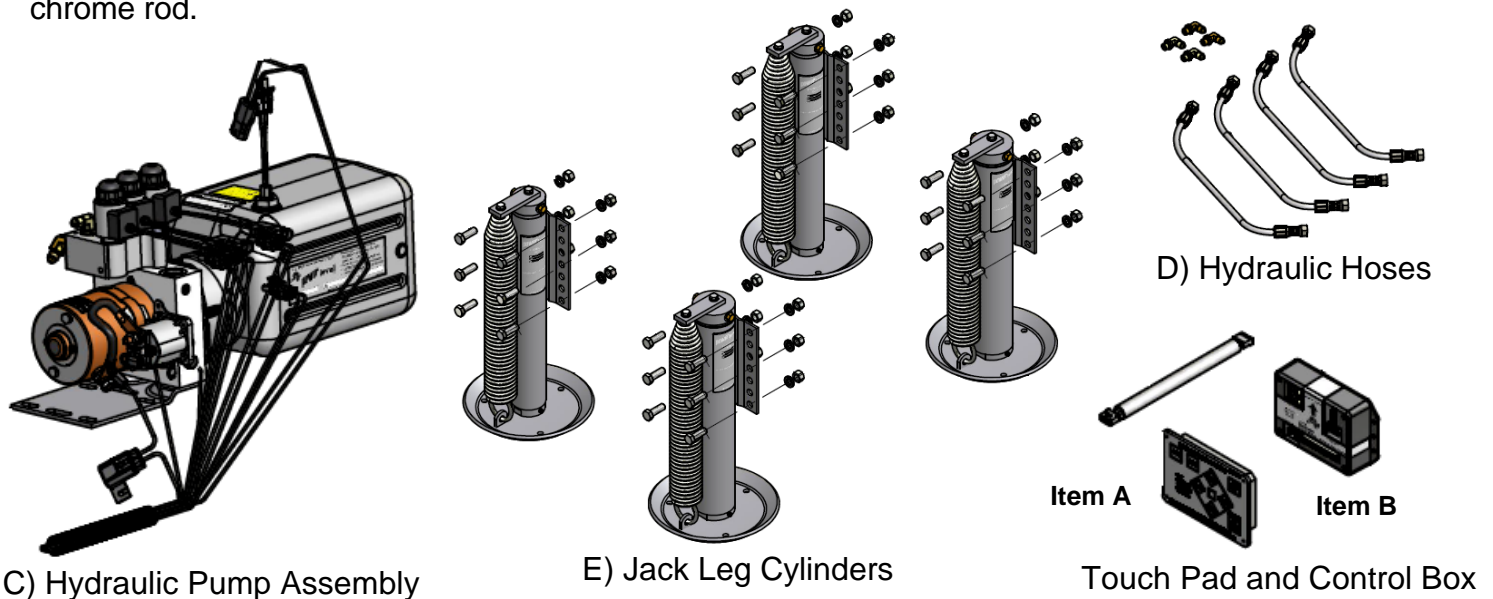

# RECOMMENDED HYDRAULIC FLUIDS

The fluids listed here are acceptable to use in your pump assembly. Contact the coach manufacturer or selling dealer for information about what specific fluid was installed in your system.

Please consult factory before using any other fluids.

In most applications,

- Type A automatic transmission fluid (ATF, Dexron III, etc.) will work satisfactorily.
- Mercon V is also recommended as an alternative fluid for Power Gear leveling systems operating in environments with large temperature swings

Operating in cold temperatures (less than -10° F) may cause the jacks to extend and retract slowly. For cold weather operation, fluid specially-formulated for low temperatures may be desirable,

- Mobil DTE 11M, Texaco Rando HDZ-15HVI, Kendall Hyden Glacial Blu, or any Mil. Spec. H5606 hydraulic fluids are recommended for cold weather operation.

# PREVENTATIVE MAINTENANCE PROCEDURES

To retain the quality for the leveling system use genuine Power Gear parts and service assistance. For the correct part or information for a particular leveling system always mention the part number listed on the major components label before contacting Power Gear or the O.E.M. Also know the year, make, and model of the RV you are working on for further assistance.

## WARNING:

**Your coach should be supported at both front and rear axles with jack stands before working underneath, failure to do so may result in personal injury or death.**

1. **Check the fluid level every month.** Fill the reservoir with the jacks in the fully **retracted** position. On vertical pump assemblies, the fluid should be within 1/4 inch of the fill port lip and checked only with **all** jacks retracted. On horizontal pump assemblies, the fluid level should be up to the weep hole on the side of the reservoir tank and checked only with **all** jacks retracted.
2. **Change fluid every 24 months.**
3. **Inspect and clean all hydraulic pump electrical connections every 12 months.**
4. **Remove dirt and road debris from jacks as needed.**
5. If jacks are down for extended periods, it is recommended to **spray exposed chrome rods with a silicone lubricant** every seven days for protection. If your coach is located in a salty environment (within 60 miles of coastal areas), it is recommended to spray the rods every 2 to 3 days.
6. Jacks equipped with grease fittings at the **bottom of the cylinder should be greased with light weight lithium grease** using a hand pump style grease gun only. 2 or 3 pumps should be sufficient for every 20-30 uses.
7. Do not use a high pressured was/rinse system on any of the components associated with the leveling system. This includes the pump, pump motor, wiring harness, control and touchpad. **THE USE OF A HIGH PRESSURE WASH/RINSE SYSTEM WILL VOID THE WARRANTY.**

# **GENERAL OPERATING INSTRUCTIONS**

## **TO EXTEND THE JACKS:**

1. Start the engine of the coach; this will insure proper voltage to the fuse which feeds the motor starter solenoid and control box. This fuse is provided by the O.E.M.; contact them for location and size. The batteries provide voltage to the hydraulic pump assembly and control box for correct operation. Some controls require a minimum of 13.1VDC to come out of "WAIT" mode.
2. Power the touch pad on by pressing the ON/OFF button. The LED will light up under the button indicating the touch pad is on. The touch pad will communicate with the control box to power the touch pad on; the control box will now be ready to accept the next input function.
3. Choose the function of manually leveling (MAN button) or automatically leveling (AUTO button) the coach by selecting the corresponding button.
  - Press the AUTO button and it will dump the air (if using the 4 pin AUX connector on the control box, and it is programmed accordingly) and the system will level the coach to the calibrated point stored in the control box.
  - Press and hold the MAN button for 5 seconds until the LED is lit under the button and it will dump the air (if using the 4 pin AUX connector on the control box, and it is programmed accordingly). Use the 4 directional buttons to extend the jacks. Pressing right button will operate the right rear jack; pressing left button will operate the left rear jack. Pressing the front button will operate both front jacks. Pressing the rear button will operate both rear jacks.
  - The touch pad communicates with the control box to energize the leg valve(s) to extend the jack(s) and level the coach.
4. Turn off the touch pad. The touch pad stops communicating with the control box.
5. Turn off the ignition. The control box removes the power for the touch pad.

## **TO RETRACT THE JACKS:**

1. Start the engine of the coach, this will insure proper voltage to the fuse which feeds the motor starter solenoid and control box. This fuse is provided by the O.E.M.; contact them for location and size.
2. Power the touch pad on by pressing the ON/OFF button. The LED will light up under the button indicating the touch pad is on. The touch pad will communicate with the control box, and will now be ready to accept the next input function from the touch pad.
3. Press and release the RETRACT ALL JACKS button. The touch pad communicates with the control box to energize the leg valves and the dump valve on the hydraulic pump assembly. The jack springs pull on the foot pads and push the fluid back into the reservoir tank of the hydraulic pump assembly.
4. When the jacks are fully retracted the "jacks down" light on the touch pad will go off. When the float switch rises to the "open" position in the reservoir tank of the pump assembly, this is communicated to the control box, which then turns off the jacks down light on the touch pad within 20-30 seconds.

# VERTICAL METAL TANK PUMP ASSEMBLIES

2003 - 2008

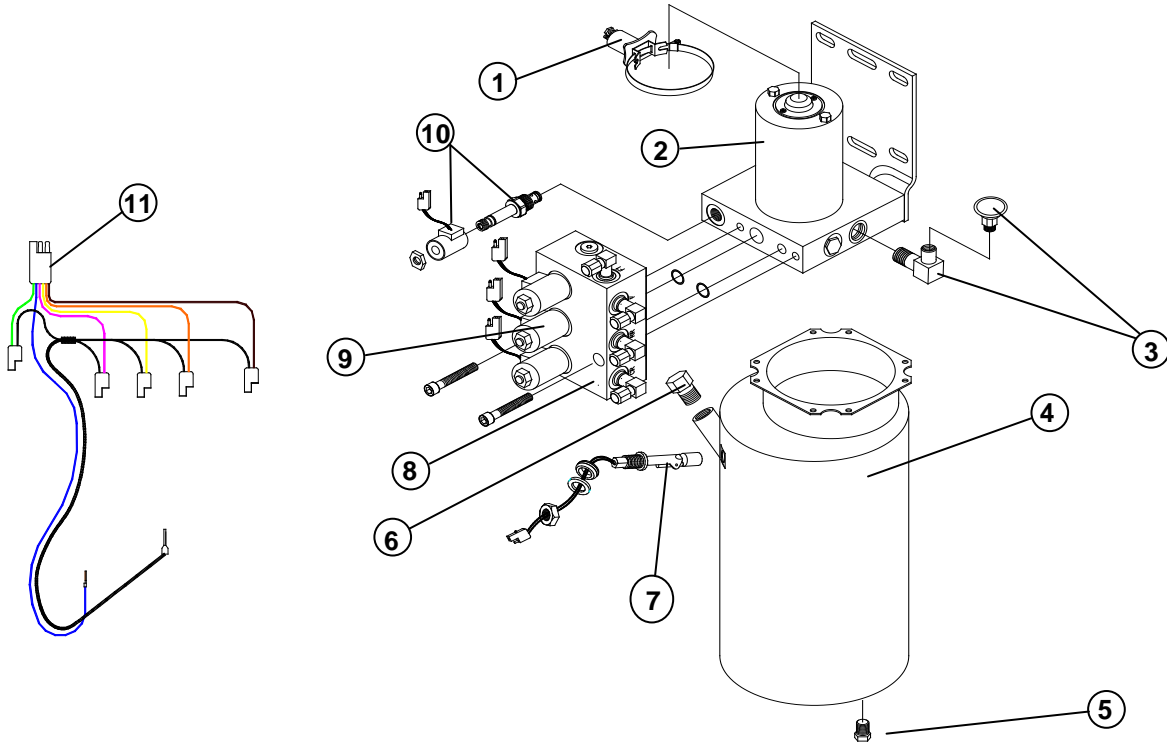

ITEM	PART #	DESCRIPTION	QTY	APPLICATION
1 - 11	500721	Complete power unit (1.5 gal. capacity)	1	2003 - 2008
	500888	Complete power unit w/manual override knob on end of valves		
	500893	Complete power unit		
	500911	Complete power unit		
8, 9	500505	Valve manifold assembly (used w/ pump # 500893)	1	1999 - present
	500641	Valve manifold assembly (used w/ pump # 500721)	1	2003 - present
	500595	Valve manifold assembly (used w/ pump # 500911)		
	500454	Valve manifold assembly w/manual override valves (used w/ 500888)		
2	800302	Motor + Bearing	1	1999 - present
4	800036S	Tank replacement service kit (2.0 gal only)		
6	07-1238	Fill plug	1	1999 - present
	130-1214	Breather cap/dip stick (used with pump # 500911 only)		
	130-1214	Push-in breather cap and dipstick		
	030-1040	Grommet, push-in breather cap		
5	07-1239	Drain plug	1	1999 - 2008
7		See T.I.P. sheet 82-L0512 for fluid sensor/float switch ID	1	
		See T.I.P. sheet 82-L0509 and 82-L0510 for testing the fluid sensor or float switch	1	
11	500661	Pump harness	1	2003 - present
	500894	Pump harness w/packard connector	1	
10	500097	Dump valve assembly w/o manual override	1	1994 - present
	500440	Dump valve assembly w/manual override knob on end of valves		
1	500310	Motor starter solenoid	1	1999 - present
3	500685	Air breather	1	1999 - 2008
1, 2, 4, 5, 6	13-1100	Pump/motor assembly (used with pump assembly # 500893) (obsolete)	1	1999 - 2008
	13-1138	Pump/motor assembly (used with pump assembly # 500721)	1	2003 - present
	130-1162	Pump/motor assembly (used with pump assembly # 500888) (obsolete)	1	2003 - 2005
	130-1189	Pump/motor assembly (used with pump assembly # 500911) (obsolete)	1	2003 - 2008
9	500099	Leg valve assembly w/trailer connector	3	1994 - present
	500439	Leg valve assembly w/packard connector and manual override knob on end of valve		



# HORIZONTAL METAL TANK PUMP ASSEMBLIES

2003 - 2006

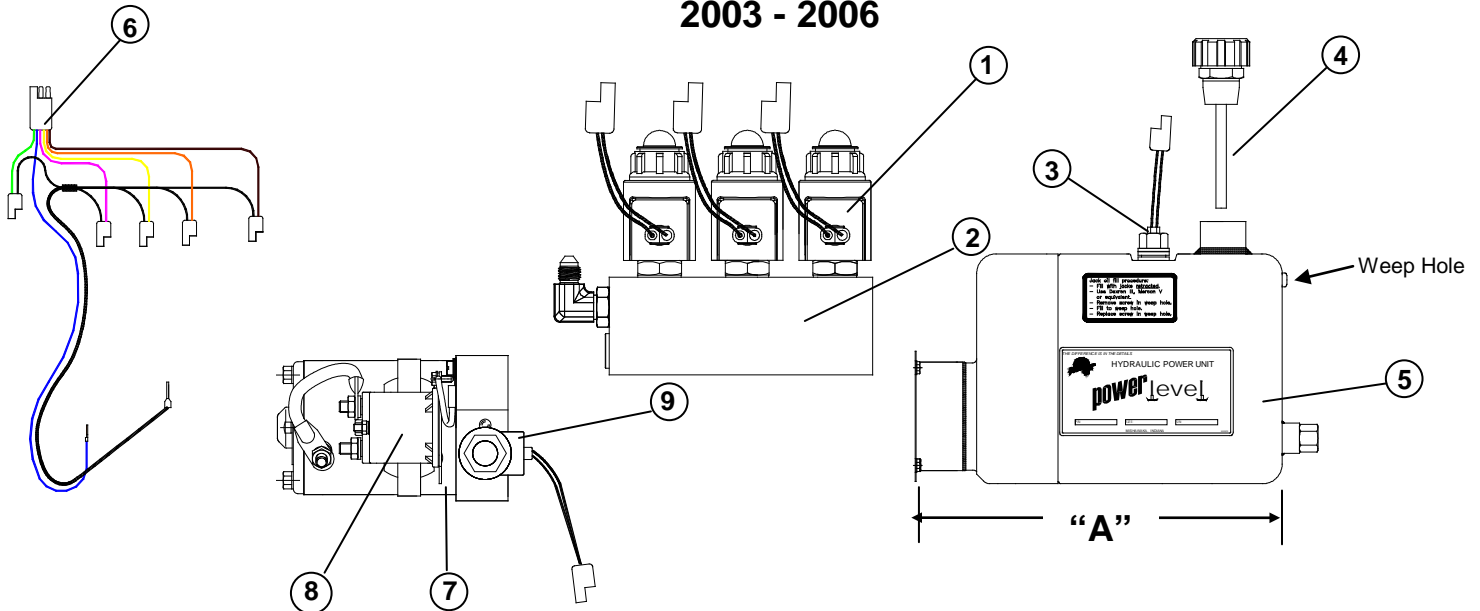

ITEM	PART #	DESCRIPTION	"A"	QTY	APPLICATION
<b>Complete 3-valve pump assy.</b>					
1-8	500773	1.0 gal. capacity w/manual override knob on end of valves (obsolete)	11.0"	1	2003 - present
	500781	1.6 gal. capacity w/manual override knob on end of valves	9.0"	1	2003 - 2006
	500825	1.0 gal. capacity w/o manual override valves (obsolete)	11.0"	1	2002 - 2004
<b>Complete 4-valve pump assy.</b>					
1-9	500197	1.5 gal. capacity w/o manual override valves (obsolete)		1	1992-1995
	500910	1.0 gal. capacity w/o manual override valves (obsolete)	9.8"	1	2003 - 2006
	500920	1.4 gal. capacity w/o manual override knob on end of valves	13.3"	1	2003 - 2006
	500925	1.4 gal capacity w/manual override knob on end of valves (obsolete)	13.3"	1	2003 - 2006
	501000	1.0 gal capacity w/manual override knob on end of valves	9.8"	1	2004 - 2006
	501013	1.4 gal capacity w/manual override knob on end of valves	13.3"	1	2004 - 2006
<b>Manifold assembly w/manual override valves</b>					
1-2	500772	Manifold assy. pump #'s 500773 & 500781		1	2003 - present
	500960	Manifold assy. pump #'s 500925 & 501000		1	2003 - present
	500641	Manifold assy. pump # 501013		1	2004 - present
<b>Manifold assembly w/o manual override valves</b>					
1-2	500959	Manifold assy. pump #'s 500910 and 500920		1	2003 - present
1	500099	Leg valve assembly w/trailer connector		3	1994 - present
	500439	Leg valve assembly w/packard connector and manual override knob on end of valve		3	1994 - present
3		See T.I.P. sheet 82-L0512 for fluid sensor/float switch ID		1	
		See T.I.P. sheet 82-L0511 for testing the fluid sensor or float switch		1	
4	130-1213	Breather cap and dipstick		1	2002 - present
	130-1214	Push-in breather cap and dipstick (pump assy. 500781)		1	2003 - present
	030-1040	Grommet, push-in breather cap		1	2003 - present
5	130-1194	1.0 gal. reservoir (obsolete)		1	2003 -
	130-1196	1.4 gal. reservoir (obsolete)		1	2003 -
6	500661	Pump harness		1	2002 - present
7	800302	Motor + Bearing only		1	2002 - present
	130-1150	Pump/motor assy. for power unit assy's 500773 and 500825			2003 - 2005
	130-1151	Pump/motor assy. for power unit assy 500781		1	2003 - 2005
	130-1193	Pump/motor assy. for power unit assy's 500910 and 501000 (obsolete)		1	2003 - 2008
	130-1195	Pump/motor assy. for power unit assy's 500920 and 500925		1	2003 - present
8	500310	Motor starter solenoid		1	1994 - present
9	500097	Dump valve assembly w/o manual override		1	1994 - present
	500440	Dump valve assembly w/manual override knob on end of valves		1	1994 - present

# 3 OR 4 JACK LEG VALVE ASSEMBLY

1999 - PRESENT

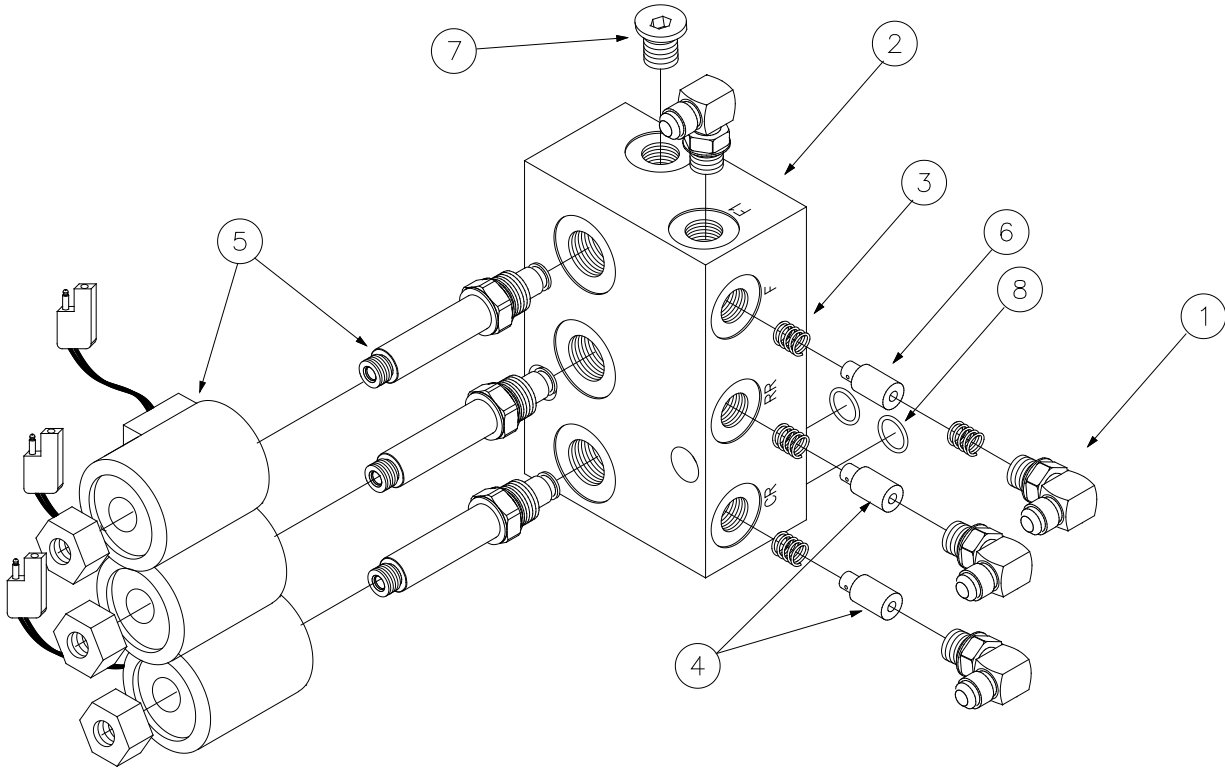

## Valve manifold assembly

ITEM	PART #	DESCRIPTION	QTY	APPLICATION
1,3,4	500636S	Rear hose connector kit	1	1999 - present
1,3,6	500637*	Front hose connector kit	1	1999 - present
5	500099	Leg valve assembly w/trailer connector (Shown)	1	1994 - present
	500439	Leg valve assembly w/packard connector and manual override knob on end of valve (Not shown)	1	
8	500523	O-ring kit	1	1999 - present
1-7	500505	Valve manifold assembly, <b>pump # 500893</b>	1	1999 - present
	500641	Valve manifold assembly, <b>pump # 500721</b>	1	2003 - present
	500454	Valve manifold assembly, <b>pump # 500888</b>		
	500772	Valve manifold assembly, <b>pump # 500773 &amp; 500781</b>		
	500960	Valve manifold assembly, <b>pump # 500925 &amp; 501000</b>		
	500959	Valve manifold assembly, <b>pump # 501013</b>		

\*"F" port has 2 springs

# VERTICAL PLASTIC TANK PUMP ASSEMBLIES

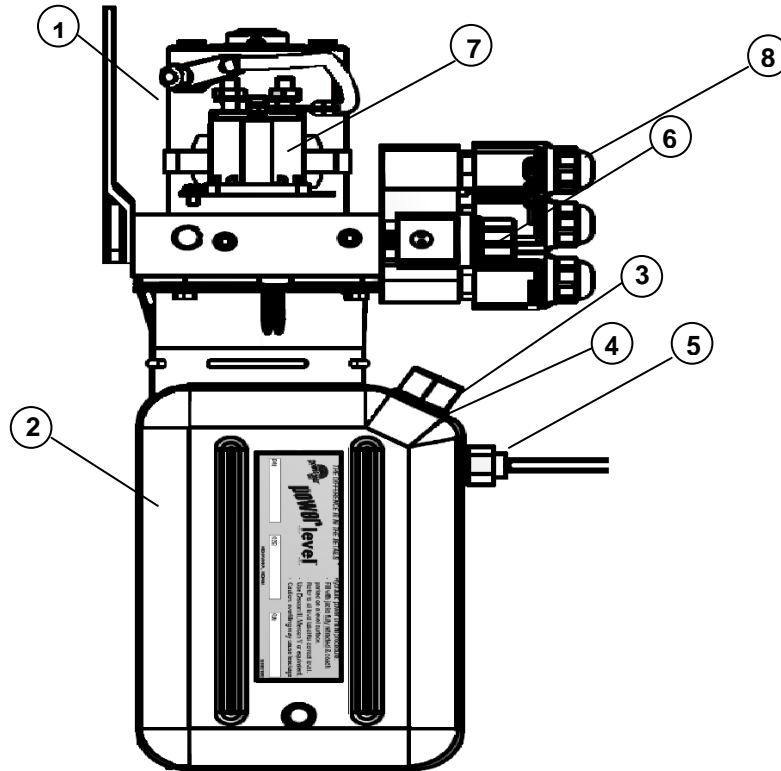

ITEM	PART #	DESCRIPTION	QTY	APPLICATION
<b>Complete 4-valve pump assembly</b>				
1-8	3510000159	1.5 gal. capacity w/manual override knob on end of valves	1	2008 - present
	3510000160	1.5 gal. capacity w/manual override knob on end of valves	1	2008 - present
	3510000161	1.5 gal. capacity w/manual override knob on end of valves	1	2008 - present
	3510000162	1.5 gal. capacity w/manual override knob on end of valves	1	2008 - present
<b>Manifold assembly w/manual override valves</b>				
6, 8	501155	Valve manifold assembly <b>(used w/ pump # 3510000159)</b>	1	2004 - present
6, 8	1010000992	Valve manifold assembly <b>(used w/ pump # 3510000160)</b>	1	2007 - present
6, 8	1010001285	Valve manifold assembly <b>(used w/ pump # 3510000161 and 3510000162)</b>	1	2007 - present
1	800302	Motor and bearing	1	1999 - present
2		For plastic tank replacement kit information see T.I.P. sheet 82-L0518	1	2012 - present
3	3010001126	Push in breather cap	1	2007 - present
4	030-1040	Grommet, push in breather cap	1	2004 - present
5		See T.I.P. sheet 82-L0512 for fluid sensor/float switch ID	1	
		See T.I.P. sheet 82-L0509 and 82-L0510 for testing the fluid sensor or float switch	1	
Not shown	500335	Pump harness w/trailer style connector (for pump assy. # 3510000159)	1	1997 - present
Not shown	1510000064	Pump harness w/packard style connector (for pump assy. # 3510000160, 3510000161 and 3510000162)	1	2007 - present
6	500567	Dump valve assembly	1	2006 - present
	500568	Dump valve assembly w/packard style connector	1	2006 - present
7	500310	Motor starter solenoid	1	1999 - present
1,2	3510000146	Pump /motor / tank assy.	1	2008 - present
8	500099	Leg valve assembly w/trailer connector	3	1994 - present
8	500439	Leg valve assembly w/packard connector and manual override knob on end of valve	3	1994 - present

# HORIZONTAL PLASTIC TANK PUMP ASSEMBLIES

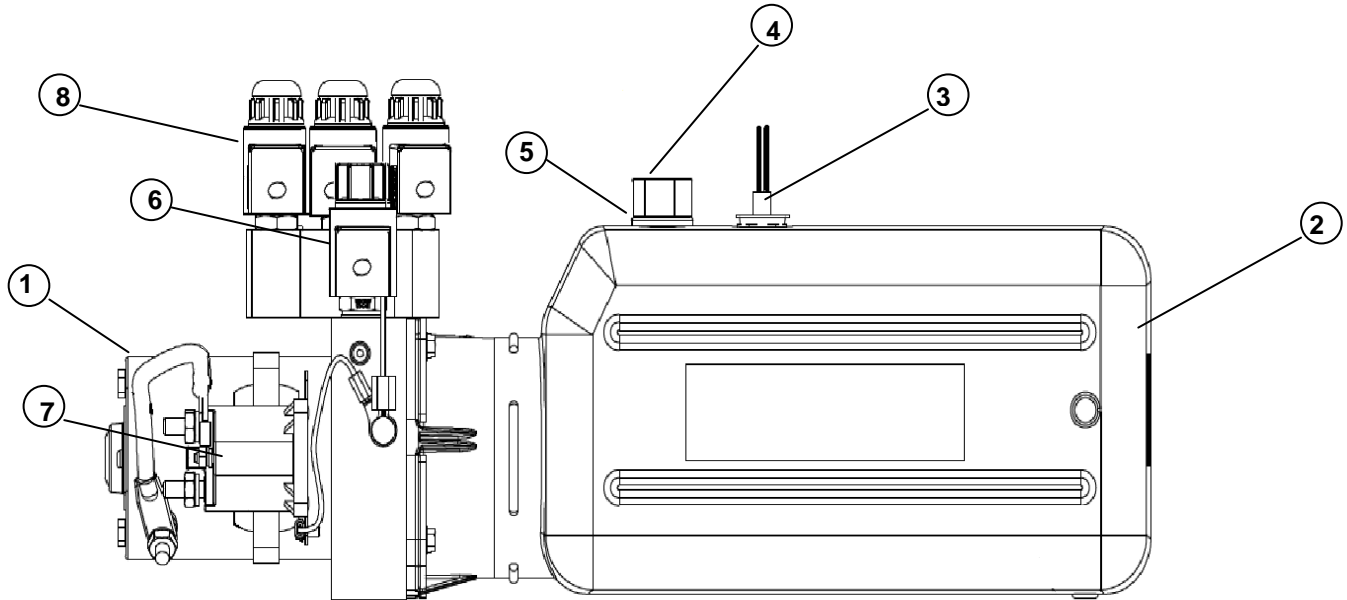

ITEM	PART #	DESCRIPTION	QTY	APPLICATION
<b>Complete 4-valve pump assy.</b>				
1-8	1010000917	2.0 gal. capacity w/manual override knob on end of valves	1	2007 - present
	1010000918	2.0 gal. capacity w/manual override knob on end of valves	1	2007 - present
	3510000013	2.0 gal. capacity w/manual override knob on end of valves	1	2006 - present
	3510000152	1.5 gal. capacity w/manual override knob on end of valves	1	2008 - present
<b>Manifold assembly w/manual override valves</b>				
6,8	500960	Valve manifold assembly <b>(used w/pump # 1010000917)</b>	1	2003 - present
	501197	Valve manifold assembly <b>(used w/pump # 1010000918 and 3510000013)</b>	1	2003 - present
	1010000991	Valve manifold assembly <b>(used w/pump # 3510000152)</b>	1	2007 - present
1	800302	Motor and bearing	1	1999 - present
2		For plastic tank replacement kit information see T.I.P. sheet 82-L0518	1	2012 - present
3		See T.I.P. sheet 82-L0512 for fluid sensor/float switch ID		
		See T.I.P. sheet 82-L0511 for testing the fluid sensor or float switch		
4	3010001126	Push in breather cap	1	2007 - present
5	030-1040	Grommet, push in breather cap	1	2004 - present
Not shown	141-0015016	Pump harness (used on pump assemblies # 1010000917, 3510000013)	1	2004 - present
Not shown	141-0036	Pump harness (used on pump assembly 1010000918)	1	2005 - present
Not shown	1510000064	Pump harness (used on pump assembly 3510000152)	1	2007 - present
6	500633	Dump valve	1	2006 - present
	500568	Dump valve w/packard connector	1	2006 - present
7	500310	Motor starter solenoid	1	1999 - present
1,2	3510000011	Pump /motor / tank assy. (2.0 gal)	1	2006 - present
1,2	3510000143	Pump /motor / tank assy. (1.5 gal)	1	2008 - present
8		Leg valve assembly (09-1140 and 09-1139)	3	
	500439	Leg valve assembly w/packard connector and manual override knob on end of valve	3	1994 - present

# HOSE IDENTIFICATION GUIDE

## 1/4" Hose #

**080-XX XXX - II**

Hose fitting at each end	
Letter	Definition
A	#4 37 deg female swivel end, 7/16-20 thread per S.A.E. J514/J.I.C
B	#6 37 deg female swivel end, 9/16-18 thread per S.A.E. J514/J.I.C
C	90 deg short bend tube, #4 37 deg female swivel 7/16-20 thread per S.A.E. J514/J.I.C
D	90 deg short bend tube, #6 37 deg female swivel 9/16-18 thread per S.A.E. J514/J.I.C
E	45 deg short bent tube, #4 37 deg female swivel 7/16-20 thread per S.A.E. J514/J.I.C
F	#4 37 deg male rigid end 7/16-20 thread per S.A.E. J514/J.I.C
G	#6 37 deg male rigid end 9/16-18 thread per S.A.E. J514/J.I.C

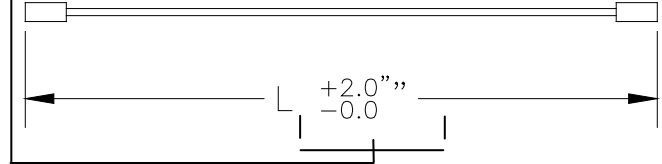

Example: Hose assembly # 080-AA264-II:

- The 080 indicates a 1/4" hose diameter
- "AA" indicates it uses a # 4 37 deg female swivel end fittings on both ends.
- The overall length of the hose is 264" long.

## 3/8" Hose #

**08- X XXX X XX**

Hose fitting at each end	
Letter	Definition
A	#4 37 deg female swivel end, 7/16-20 thread per S.A.E. J514/J.I.C
B	#6 37 deg female swivel end, 9/16-18 thread per S.A.E. J514/J.I.C
C	90 deg short bend tube, #4 37 deg female swivel 7/16-20 thread per S.A.E. J514/J.I.C
D	90 deg short bend tube, #6 37 deg female swivel 9/16-18 thread per S.A.E. J514/J.I.C
E	45 deg short bent tube, #4 37 deg female swivel 7/16-20 thread per S.A.E. J514/J.I.C
F	#4 37 deg male rigid end 7/16-20 thread per S.A.E. J514/J.I.C
G	#6 37 deg male rigid end 9/16-18 thread per S.A.E. J514/J.I.C

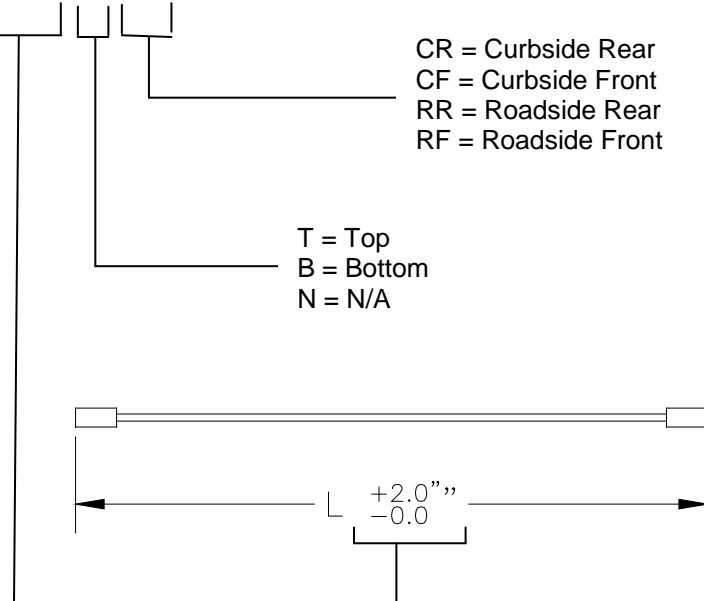

Example: Hose assembly # 08-A360TRR:

- The 08 indicates 3/8" hose diameter
- "A" indicates it uses a #4 37 deg female swivel end fittings on both ends
- The overall length of the hose is 360" long
- TRR indicates it connects to the top port of the roadside rear jack.

# HYDRAULIC FITTINGS

## Fittings:

**070-1261**

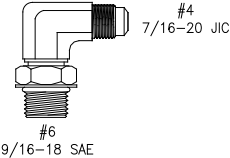

**070-1267**

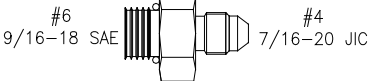

**070-1268**

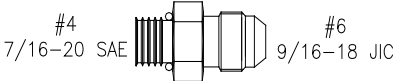

**070-1269**

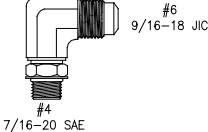

**07-1059**

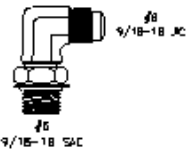

**070-1262**

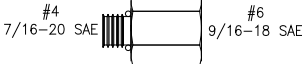

**WO11380**

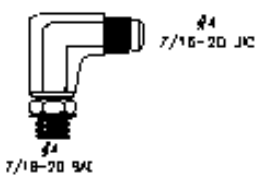

## Reducers:

**070-1258**

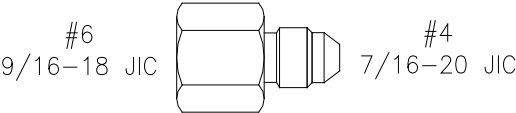

**070-1263**

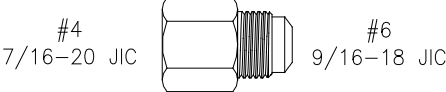

# MANUAL TOUCH PAD CONTROL

2004-Present

500731 touchpad control (front view)

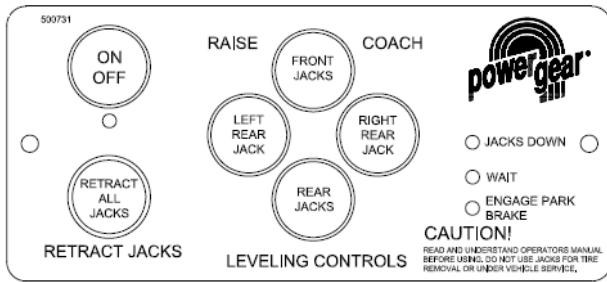

500731 touchpad control (rear view)

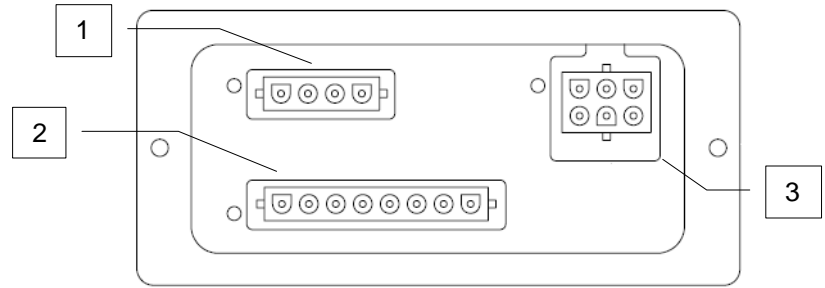

ITEM	NOTE	PART #	DESCRIPTION	QTY	APPLICATION
1	Not shown	5013-161	Auxiliary harness connector	1	2004 - present
2	Not shown	5021-XXX	Pump harness connector	1	2004 - present
		141-0005XXX	Pump harness (with fuse)		
3	Not shown	5010-XXX	Main power connector	1	2004 - present
		5018-XXX			

"-XXX" = length of harness in inches

Note: See TIP Sheet # 204 for calibration instructions.

### Item #1 – Auxiliary Harness Connector

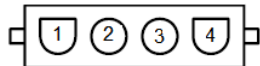

- Pin #1** Fill output to the airbag valve. Energized with +12vdc to fill airbags.
- Pin #2** Fill output to the airbag valve. Ground to fill airbags.
- Pin #3** Dump output to the airbag valve. Energized with +12vdc to dump airbags.
- Pin #4** Dump output to the airbag valve. Ground to dump airbags.

### Item #3 – Main Power Connector

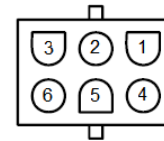

- Pin #1** Input from park brake. Has continuity to ground when the park brake is engaged.
- Pin #2** Input from neutral safety switch. Can measure as either +12vdc or ground.
- Pin #3** Not used.
- Pin #4** Not used.
- Pin #5** Input from ignition. Energized with +12vdc when the coach is running.
- Pin #6** Input from neutral safety switch. Can measure as either +12vdc or ground.

### Item #2 – Pump Harness Connector

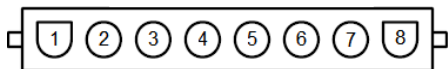

- Pin #1** Ground input.
- Pin #2** Float switch input. See TIP sheets 82-L0509, 82-L0510 and 82-L0511 to determine proper signals.
- Pin #3** Output to motor starter solenoid. Energized with +12vdc when the front/rear/left/right button(s) are pushed.
- Pin #4** Output to dump valve. Energized with +12vdc when the "retract all jacks" button is pushed.
- Pin #5** Output to roadside rear leg valve. Energized with +12vdc when left or rear button or retract button is pushed.
- Pin #6** Output to curbside rear leg valve. Energized with +12vdc when right or rear button or retract button is pushed.
- Pin #7** Output to front jack leg valve. Energized with +12vdc when front button or retract button is pushed.
- Pin #8** Input from motor starter solenoid. Energized with +12vdc to supply power to the touchpad control

# SEMI-AUTOMATIC TOUCHPAD & CONTROLS 2002-2005

500675 touchpad **Obsolete – use 500675S kit**

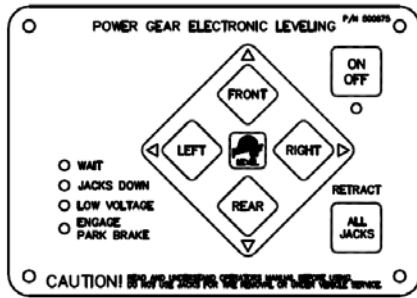

500674 control box **Obsolete – use 500674S kit**

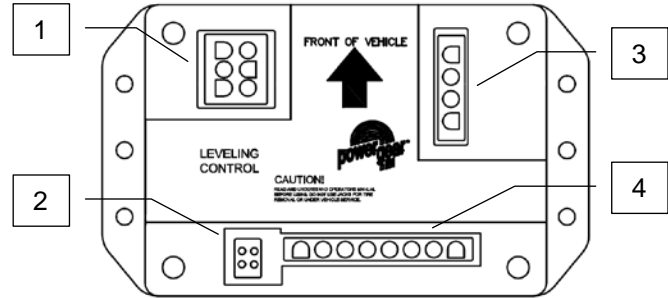

ITEM	NOTE	PART #	DESCRIPTION	QTY	APPLICATION
1	Not shown	5020-XXX 5018-XXX	Main power connector	1	2002 - present
2	Not shown	5019-XXX	Touch pad harness connector <b>Obsolete</b>	1	2002 - 2005
3	Not shown	5013-161	Auxiliary harness connector	1	2002 - present
4	Not shown	5021-XXX	Pump harness connector	1	2002 - present
		500673	Semi-auto control kit (touchpad, control box, touchpad harness)		2002 - present

“-XXX” = length of harness in inches

Note: See TIP Sheet # 152 for calibration instructions.

## Item #1 – Main Power Connector

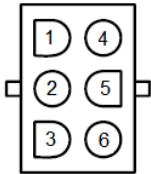

- Pin #1** Input from park brake. Has continuity to ground when the park brake is engaged.
- Pin #2** Input from neutral safety switch. Can measure as either +12vdc or ground.
- Pin #3** Not used.
- Pin #4** Not used.
- Pin #5** Input from ignition. Energized with +12vdc when the coach is running.
- Pin #6** Input from neutral safety switch. Can measure as either +12vdc or ground.

## Item #3 – Auxiliary Harness Connector

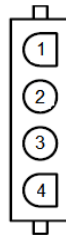

- Pin #1** Fill output to the airbag valve. Energized with +12vdc to fill airbags.
- Pin #2** Fill output to the airbag valve. Ground to fill airbags.
- Pin #3** Dump output to the airbag valve. Energized with +12vdc to dump airbags.
- Pin #4** Dump output to the airbag valve. Ground to dump airbags.

## Item #4 – Pump Harness Connector

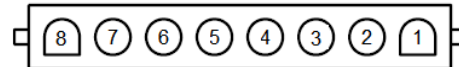

- Pin #1** Ground input.
- Pin #2** Float switch input. See TIP sheets 82-L0509, 82-L0510 and 82-L0511 to determine proper signals.
- Pin #3** Output to motor starter solenoid. Energized with +12vdc when the front/rear/left/right button(s) are pushed.
- Pin #4** Output to dump valve. Energized with +12vdc when the "retract all jacks" button is pushed.
- Pin #5** Output to roadside rear leg valve. Energized with +12vdc when left or rear button or retract button is pushed.
- Pin #6** Output to curbside rear leg valve. Energized with +12vdc when right or rear button or retract button is pushed.
- Pin #7** Output to front jack leg valve. Energized with +12vdc when front button or retract button is pushed.
- Pin #8** Input from motor starter solenoid. Energized with +12vdc to supply power to the touchpad control

## Item #2 – Touch Pad Harness Connector

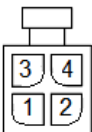

- Pin #1** Output to the touchpad. Transmit signal 5-7vdc.
- Pin #2** Input from the touchpad. Receive signal 5-7vdc.
- Pin #3** Power (+12vdc) output to the touchpad.
- Pin #4** Ground output to the touchpad.



# SEMI-AUTOMATIC TOUCHPAD & CONTROL 2006-Present

140-1231 touchpad

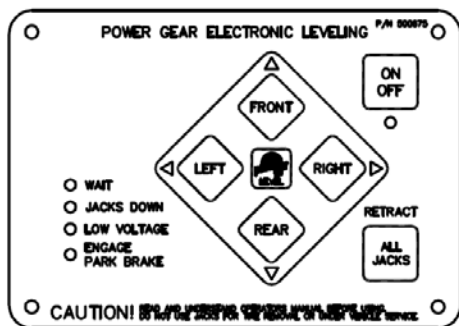

140-1230 control box

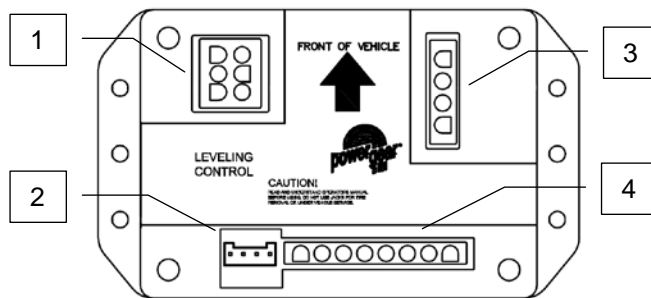

ITEM	NOTE	PART #	DESCRIPTION	QTY	APPLICATION
1	Not shown	5020-XXX	Main power connector	1	2002 - present
		5018-XXX			
2	Not shown	141-0045XXX	Touch pad harness connector	1	2005 - present
3	Not shown	5013-161	Auxiliary harness connector	1	2002 - present
4	Not shown	5021-XXX	Pump harness connector	1	2002 - present
		500673			

"-XXX" = length of harness in inches

Note: See TIP Sheet # 152 for calibration instructions.

## Item #1 – Main Power Connector

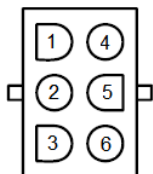

- Pin #1** Input from park brake. Has continuity to ground when the park brake is engaged.
- Pin #2** Input from neutral safety switch. Can measure as either +12vdc or ground.
- Pin #3** Not used.
- Pin #4** Not used.
- Pin #5** Input from ignition. Energized with +12vdc when the coach is running.
- Pin #6** Input from neutral safety switch. Can measure as either +12vdc or ground.

## Item #3 – Auxiliary Harness Connector

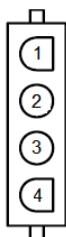

- Pin #1** Fill output to the airbag valve. Energized with +12vdc to fill airbags.
- Pin #2** Fill output to the airbag valve. Ground to fill airbags.
- Pin #3** Dump output to the airbag valve. Energized with +12vdc to dump airbags.
- Pin #4** Dump output to the airbag valve. Ground to dump airbags.

## Item #4 – Pump Harness Connector

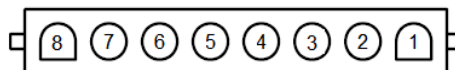

- Pin #1** Ground input.
- Pin #2** Float switch input. See TIP sheets 82-L0509, 82-L0510 and 82-L0511 to determine proper signals.
- Pin #3** Output to motor starter solenoid. Energized with +12vdc when the front/rear/left/right button(s) are pushed.
- Pin #4** Output to dump valve. Energized with +12vdc when the "retract all jacks" button is pushed.
- Pin #5** Output to roadside rear leg valve. Energized with +12vdc when left or rear button or retract button is pushed.
- Pin #6** Output to curbside rear leg valve. Energized with +12vdc when right or rear button or retract button is pushed.
- Pin #7** Output to front jack leg valve. Energized with +12vdc when front button or retract button is pushed.
- Pin #8** Input from motor starter solenoid. Energized with +12vdc to supply power to the touchpad control

## Item #2 – Touch Pad Harness Connector

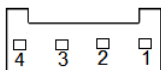

- Pin #1** Output to the touchpad. Transmit signal 5-7vdc.
- Pin #2** Input from the touchpad. Receive signal 5-7vdc.
- Pin #3** Power (+12vdc) output to the touchpad.
- Pin #4** Ground output to the touchpad.

# AUTOMATIC TOUCH PAD & CONTROL

2002-2005

500629 touchpad **Obsolete – use 500629S**

500630 control box **Obsolete – use 500630S**

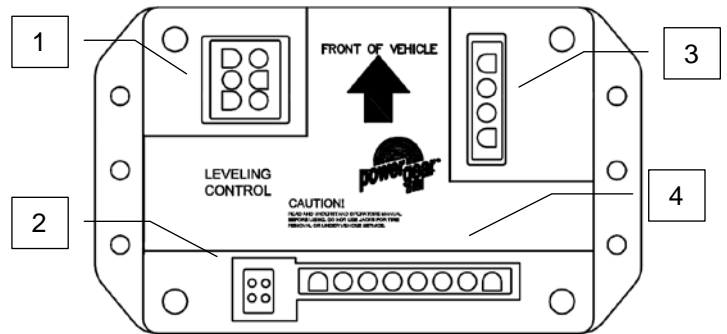
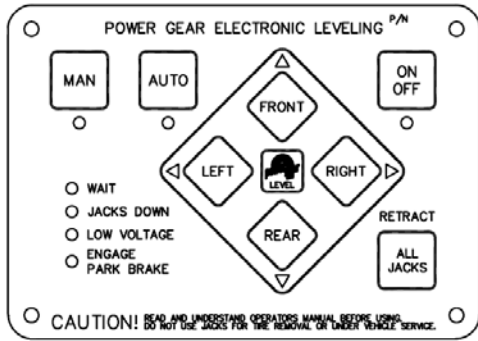

ITEM	NOTE	PART #	DESCRIPTION	QTY	APPLICATION
1	Not shown	5020-XXX	Main power connector	1	2002 - present
2	Not shown	5019-XXX	Touch pad harness connector <b>Obsolete</b>	1	2002 - 2005
3	Not shown	500771	Auxiliary harness connector	1	2002 - present
		500787			
		5013-XXX			
4	Not shown	5021-XXX	Pump harness connector	1	2002 - present
		500643s	Automatic control kit (touchpad, control box, touchpad harness)		

“-XXX” = length of harness in inches

Note: See TIP Sheet # 153 for calibration

## Item #1 – Main Power Connector

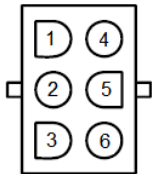

- Pin #1** Input from park brake. Has continuity to ground when the park brake is engaged.
- Pin #2** Input from neutral safety switch. Can measure as either +12vdc or ground.
- Pin #3** Not used.
- Pin #4** Not used.
- Pin #5** Input from ignition. Energized with +12vdc when the coach is running.
- Pin #6** Input from neutral safety switch. Can measure as either +12vdc or ground.

## Item #2 – Touch Pad Harness Connector

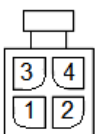

- Pin #1** Output to the touchpad. Transmit signal 5-7vdc.
- Pin #2** Input from the touchpad. Receive signal 5-7vdc.
- Pin #3** Power (+12vdc) output to the touchpad.
- Pin #4** Ground output to the touchpad.

## Item #3 – Auxiliary Harness Connector

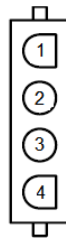

- Pin #1** Fill output to the airbag valve. Energized with +12vdc to fill airbags.
- Pin #2** Fill output to the airbag valve. Ground to fill airbags.
- Pin #3** Dump output to the airbag valve. Energized with +12vdc to dump airbags.
- Pin #4** Dump output to the airbag valve. Ground to dump airbags.

## Item #4 – Pump Harness Connector

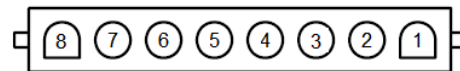

- Pin #1** Ground input.
- Pin #2** Float switch input. See TIP sheets 82-L0509, 82-L0510 and 82-L0511 to determine proper signals.
- Pin #3** Output to motor starter solenoid. Energized with +12vdc when the front/rear/left/right button(s) are pushed.
- Pin #4** Output to dump valve. Energized with +12vdc when the "retract all jacks" button is pushed.
- Pin #5** Output to roadside rear leg valve. Energized with +12vdc when left or rear button or the retract button is pushed.
- Pin #6** Output to curbside rear leg valve. Energized with +12vdc when right or rear button or retract button is pushed.
- Pin #7** Output to front jack leg valve. Energized with +12vdc when the front button or retract button is pushed.
- Pin #8** Input from motor starter solenoid. Energized with +12vdc to supply power to the touchpad control

# AUTOMATIC TOUCH PAD & CONTROL

2005-Present

140-1226 touchpad

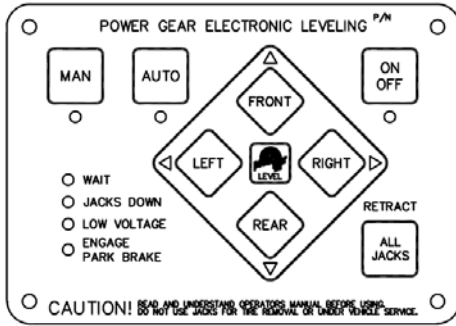

140-1227 and 9010000156 control box

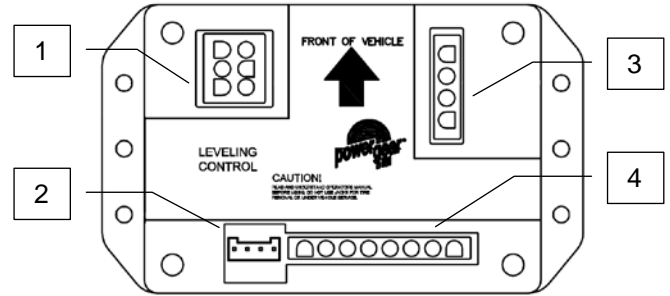

ITEM	NOTE	PART #	DESCRIPTION	QTY	APPLICATION
1	Not shown	5020-XXX	Main power connector	1	2002 - present
2	Not shown	141-0045XXX	Touch pad harness connector	1	2006 - present
3	Not shown	500771	Auxiliary harness connector	1	2002 - present
		500787			
		5013-XXX			
4	Not shown	5021-XXX	Pump harness connection	1	2002 - present

"-XXX" = length of harness in inches

Note: See TIP Sheet # 153 for calibration

### Item #1 – Main Power Connector

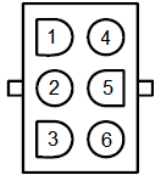

- Pin #1** Input from park brake. Has continuity to ground when the park brake is engaged.
- Pin #2** Input from neutral safety switch. Can measure as either +12vdc or ground.
- Pin #3** Not used.
- Pin #4** Not used.
- Pin #5** Input from ignition. Energized with +12vdc when the coach is running.
- Pin #6** Input from neutral safety switch. Can measure as either +12vdc or ground.

### Item #3 – Auxiliary Harness Connector

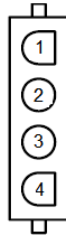

- Pin #1** – Fill output to the airbag valve. Energized with +12vdc to fill airbags.
- Pin #2** – Fill output to the airbag valve. Ground to fill airbags.
- Pin #3** – Dump output to the airbag valve. Energized with +12vdc to dump airbags.
- Pin #4** – Dump output to the airbag valve. Ground to dump airbags.

### Item #2 – Touch Pad Harness Connector

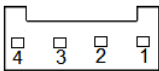

- Pin #1** Output to the touchpad. Transmit signal 5-7vdc.
- Pin #2** Input from the touchpad. Receive signal 5-7vdc.
- Pin #3** Power (+12vdc) output to the touchpad.
- Pin #4** Ground output to the touchpad.

### Item #4 – Pump Harness Connector

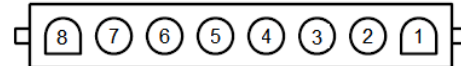

- Pin #1** Ground input.
- Pin #2** Float switch input. See TIP sheets 82-L0509, 82-L0510 and 82-L0511 to determine proper signals.
- Pin #3** Output to motor starter solenoid. Energized with +12vdc when the front/rear/left/right button(s) are pushed.
- Pin #4** Output to dump valve. Energized with +12vdc when the "retract all jacks" button is pushed.
- Pin #5** Output to roadside rear leg valve. Energized with +12vdc when left or rear button or retract button is pushed.
- Pin #6** Output to curbside rear leg valve. Energized with +12vdc when right or rear button or retract button is pushed.
- Pin #7** Output to front jack leg valve. Energized with +12vdc when front button or retract button is pushed.
- Pin #8** Input from motor starter solenoid. Energized with +12vdc to supply power to the touchpad control

140-1226 touchpad

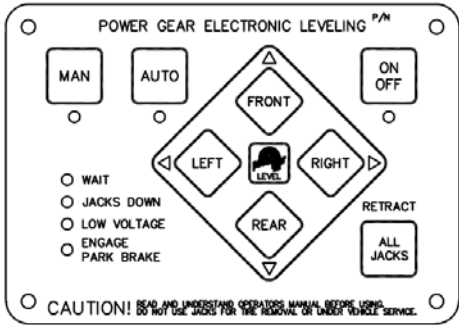

1010001002, 1010001284 and 1010002348 control box

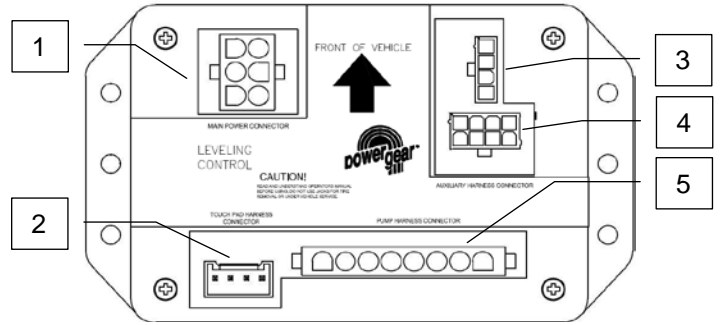

ITEM	NOTE	PART #	DESCRIPTION	QTY	APPLICATION
1	N	5020-XXX	Main power connector	1	2002 - present
2	N	141-0045XXX	Touch pad harness connector	1	2006 - present
3	N	N/A	Auxiliary harness 2 connector	1	2002 - present
4		N/A	Auxiliary harness connector	1	2002 - present
5	N	5021-XXX	Pump harness connector	1	2002 - present

"-XXX" = length of harness in inches

### Item #1 – Main Power Connector

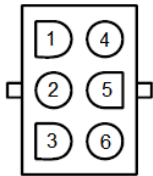

- Pin #1** Input from park brake. Has continuity to ground when the park brake is engaged.
- Pin #2** Input from neutral safety switch. Can measure as either +12vdc or ground.
- Pin #3** Not used.
- Pin #4** Not used.
- Pin #5** Input from ignition. Energized with +12vdc when the coach is running.
- Pin #6** Input from neutral safety switch. Can measure as either +12vdc or ground.

### Item #3 – Auxiliary Harness 2 Connector

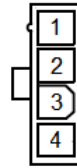

- Pin #1** Ignition Accessory +12vdc lights rocker switch
- Pin #2** No connection (open)
- Pin #3** No connection (open)
- Pin #4** No connection (open)

### Item #4 – Auxiliary Harness Connector



- Pin #1** Remote status +12vdc output
- Pin #2** Remote status ground output
- Pin #3** Dash light +12vdc output
- Pin #4** Dash light ground output
- Pin #5** External auto
- Pin #6** External retract
- Pin #7** Air dump output +12vdc
- Pin #8** Air fill output +12vdc

### Item #2 – Touch Pad Harness Connector

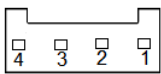

- Pin #1** Output to the touchpad. Transmit signal 5-7vdc.
- Pin #2** Input from the touchpad. Receive signal 5-7vdc.
- Pin #3** Power (+12vdc) output to the touchpad.
- Pin #4** Ground output to the touchpad.

### Item #5 – Pump Harness Connector

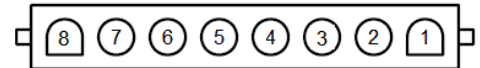

- Pin #1** Ground input.
- Pin #2** Float switch input. See TIP sheets 82-L0509, 82-L0510 and 82-L0511 to determine proper signals.
- Pin #3** Output to motor starter solenoid. Energized with +12vdc when the front/rear/left/right button(s) are pushed.
- Pin #4** Output to dump valve. Energized with +12vdc when the "retract all jacks" button is pushed.
- Pin #5** Output to roadside rear leg valve. Energized with +12vdc when left or rear button or retract button is pushed.
- Pin #6** Output to curbside rear leg valve. Energized with +12vdc when right or rear button or retract button is pushed.
- Pin #7** Output to front jack leg valve. Energized with +12vdc when front button or retract button is pushed.
- Pin #8** Input from motor starter solenoid. Energized with +12vdc to supply power to the touchpad control

**Wiring diagram for systems with control box part #'s 500731, 500674, 140-1230, 500630, 140-1227 and 9010000156**

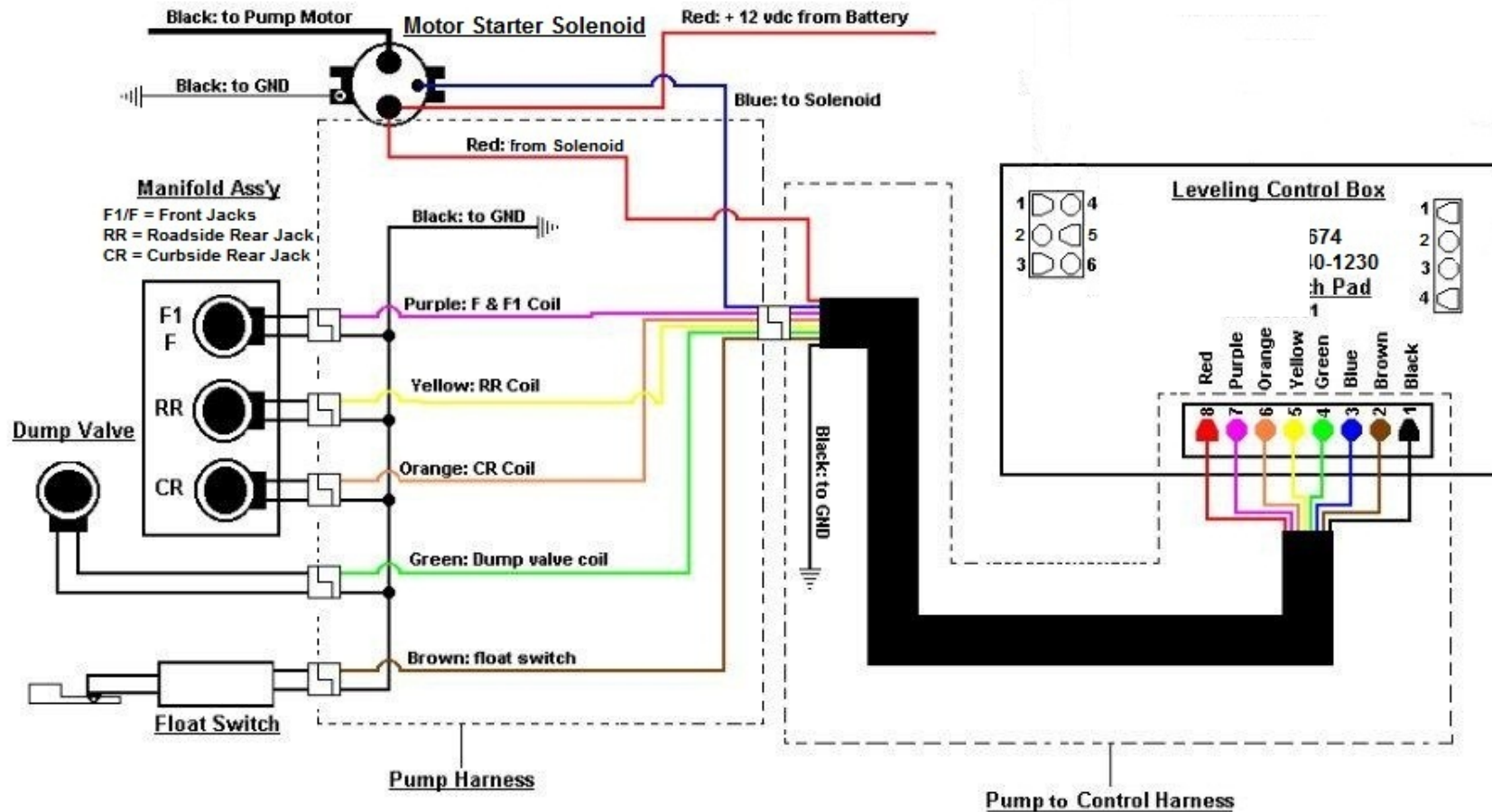

**Please Note:** Horizontal pump assemblies 500773, 500781, and 500825 do not use a dump valve assembly.

**Wiring diagram for systems with control box part #'s 1010001002, 1010002348 and 1010001284**

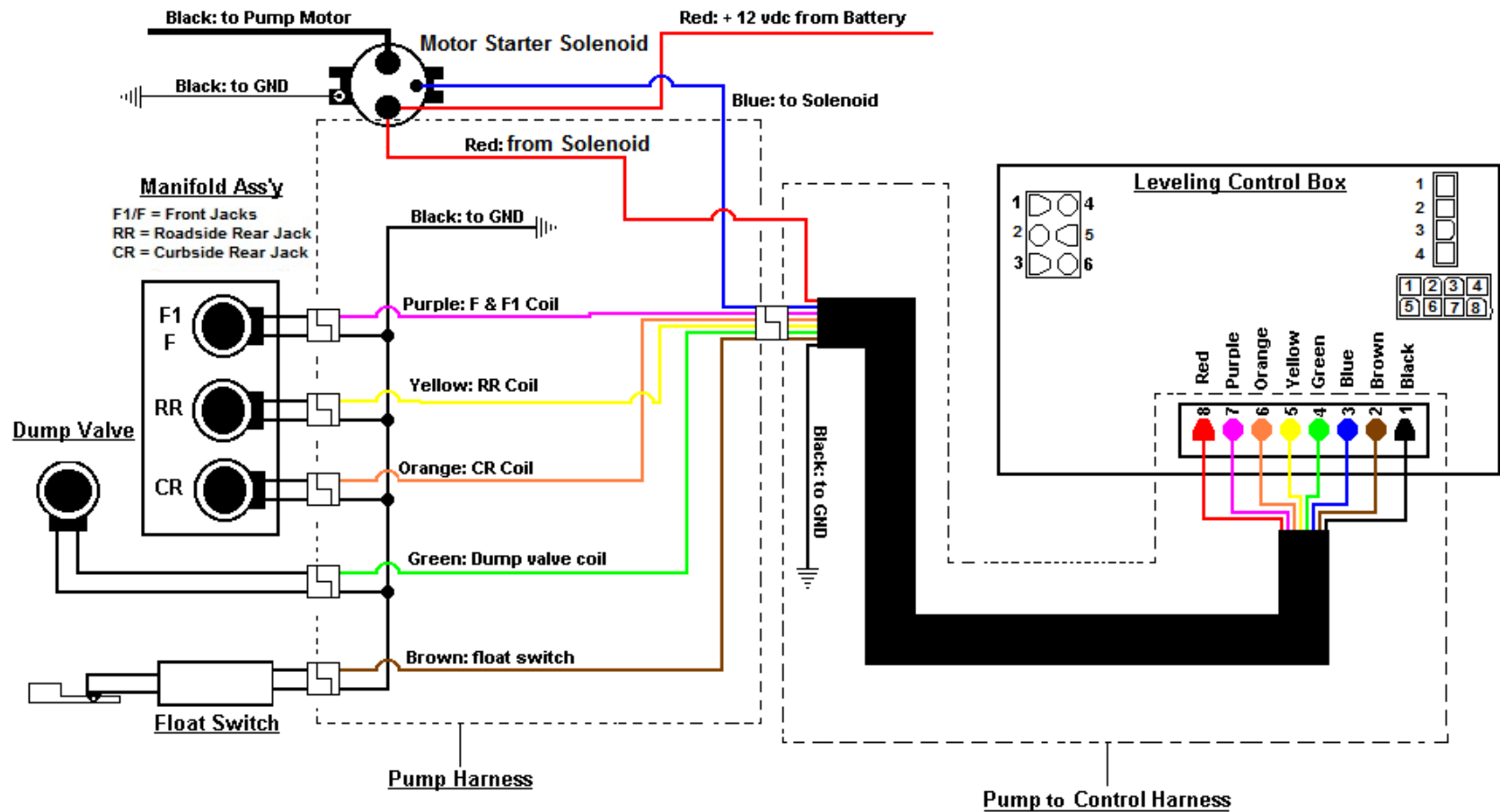



## TROUBLESHOOTING

<b>TOUCH PAD WILL NOT TURN ON, ON/OFF LED DOES NOT LIGHT</b>	
<b>PROBABLE CAUSE</b>	<b>CORRECTIVE ACTION</b>
Coach ignition not in run position	Turn ignition to run position and have engine running.
Touch pad has been left on for more than four minutes, auto shut off has occurred	Push ON/OFF button until LED is lit on touch pad.
No voltage at the touchpad.	Check harness at the touchpad on the 4 pin connector (see wiring diagram): Check between pin #3 (black power wire) and pin #4 (blue or green ground wire). There should be 10-12 vdc between the pins.
No voltage out of control box to the touchpad.	Check power out of control box at the 4 pin connector (see wiring diagram): Check between pin #3 (black power wire) and pin #4 (blue or green ground wire). There should be 10-12 vdc between the pins.
No power to control box on ignition input signal	On the control box at the 6 pin connector (see wiring diagram): Check incoming voltage between pin #5 (ignition) and pin #1 (ground) of the 8 pin connector. There should be +12vdc between the pins. If low or no voltage is found, contact the OEM for further troubleshooting.
Damaged or broken touchpad harness	Check connectors and wires for damage or broken wires. Fix accordingly.
Ground wire disconnected or shorted at control box	Pin 1 of the 8 pin connector is the main ground. Test from pin 1 to chassis ground, there should be continuity with ground. If none is found, repair or replace ground wire.
Neutral safety switch wires shorted or broken at control box	On the control box at the 6 pin connector (see wiring diagram): Check for voltage at pin #6. If it has +12vdc verify pin #2 at the 6 pin connector also has +12vdc. If pin #2 is ground, ground pin #6. If the control then operates, repair or replace wires or neutral safety switch.
Parking brake wire not grounded, or faulty parking brake switch	On the control box check for continuity between pin #1 of the 6 pin connector and ground. If there is no continuity, the switch is bad, the parking brake is not set, or the wires to the switch are bad.
Faulty touch pad	If all previous causes and actions do not apply replace touch pad.

<b>JACKS WILL NOT EXTEND AND THE PUMP IS NOT RUNNING</b>	
<b>PROBABLE CAUSE</b>	<b>CORRECTIVE ACTION</b>
Coach ignition not in run position	Turn ignition to run position and have engine running.
Touch pad has been left on for more than four minutes, auto shut off has occurred	Push ON/OFF button until LED is lit on touch pad.
No power from battery to pump	Check for +12vdc at the large battery terminal of the motor solenoid, if no voltage or if voltage is less than +12vdc, recharge battery or replace power cable.
Bad ground to pump assembly	Inspect / clean surface of star washers around mounting bolt holes of pump assembly. The bolts lock into the pump block assembly through the pump mounting plate. Add a new ground from chassis to pump motor bolts.
Motor starter solenoid blue wire defective (see wiring diagram)	Check for +12vdc at the blue signal wire at the motor starter solenoid when the front or rear button is pushed. If no voltage, check blue wire at pin #3 of the 8 pin connector for +12vdc when the front or rear button is pushed. If no voltage is present, remove blue wire from starter solenoid and check again at pin #3 for +12vdc while front or rear button is pushed. If there is +12vdc, check the blue wire for continuity, if no continuity replace or repair blue wire. If no voltage is present at Pin 3, contact Power Gear Technical Support.
Motor starter solenoid defective	Check for +12vdc at the blue signal wire at the motor starter solenoid when the front or rear button is pushed. If no voltage, check blue wire at pin #3 of the 8 pin connector for +12vdc when the front or rear button is pushed. If voltage is present, connect +12vdc to motor side terminal of starter solenoid; if motor runs, replace starter solenoid.
Pump motor defective	Check for continuity between the motor and ground. Connect +12vdc to motor side terminal of motor starter solenoid; if motor does not run, replace pump motor (see TIP sheet 216 for details).

<b>ONE OR MORE JACKS WILL NOT EXTEND AND THE PUMP IS RUNNING</b>	
<b>PROBABLE CAUSE</b>	<b>CORRECTIVE ACTION</b>
Coach ignition not in run position	Turn ignition to run position and have engine running.
Fluid level low; pump cavitating	Fill tank to proper level with automatic transmission fluid (see TIP sheet 140).
No power at control box to energize valve coils (see wiring diagram)	Check for +12vdc at the control box between pin #8 (power) and pin #1 (ground) of the 8 pin connector. If there is no voltage present then see wiring diagram for power and ground inputs.
Dump valve stuck open or defective valve	Remove the dump valve assembly and bench test it by applying power and ground to the coil (not polarity sensitive). The valve should click as you apply power and ground, you can also see the pin moving in the end of the valve. If the valve clicks but you do not have pin movement, replace dump valve. NOTE- If there still is no pressure after replacing the valves, the pump may be faulty. See TIP sheet 215 for pump diagnostic details.
Leg valve wires damaged	Check for +12vdc at leg valve wires (see wiring diagram) at the pump assembly while pushing the front button or the rear button depending on which jack leg valve you are testing. If no +12vdc signal, check for continuity on each wire between coil and controller. Check for ground at the black wire or red wire for each leg valve at the pump assembly. Repair if necessary.
Valve coil miss wired	Check wiring diagram for correct location of wiring to the leg valve assemblies.
Leg valve coil defective	Check coil for continuity, if none replace valve coil.
Leg valve defective	Swap jack leg valve with one of the working jack leg valves and extend jacks. If jack(s) extend then replace cartridge valve.
Pump harness defective	Check for ground at the black or red wire for each leg valve at pump assembly harness. If there is none, repair the wire.
	While pushing the button to extend the jacks, check for +12vdc at the purple, orange and yellow wires at the leg valves. If no voltage is measured check for +12vdc at the 8 pin connector on pin #7 (purple), pin #6 (orange) and pin #5 (yellow) at the control box. If voltage is present, repair the wires.
	If no voltage is present check the touchpad for trouble codes (see TIP sheet 184). If no trouble codes check for proper signals on the 6 pin harness see " <b>touch pad will not turn on, indicator light does not light</b> ". If proper signals are present, replace the controller.
Pump itself is damaged	See TIP sheet 215 for details. Remove tank and disassemble pump for visual inspection.

<b>JACK(S) WILL NOT RETRACT OR WILL NOT RETRACT FULLY</b>	
<b>PROBABLE CAUSE</b>	<b>CORRECTIVE ACTION</b>
Lubricate the jack	While the jacks are extended down spray the chrome rod with silicone spray. If the jacks have a zerk fitting in the bottom collar of the jack assembly apply all purpose lithium grease. Three pumps with a manual grease gun are recommended. Retract the jacks and then extend the jacks. Lubricate the jacks again as above. Repeat this process 2 more times.
Obstructions in jack pad	Remove any rocks or foreign material out of the foot pad before retracting the jacks.
Broken jack spring(s)	Replace jack spring (see TIP sheet 34 and TIP Sheet 82-L0505).
Jack rod guide is rusted or dirty	Clean the chrome rod and grease rod guide if equipped with grease fittings. Otherwise lubricate with silicone fluid as described above. It may be necessary to reseal jack or replace.
System overfilled with fluid	Drain fluid to the recommended level (see TIP sheet 140).
Dump valve wires damaged	While pushing retract all jacks button check for +12vdc on the green wire at the dump valve. If no +12vdc, check for continuity on green wire between coil and controller. Check for ground at the black wire at the dump valve. Repair if necessary.



Jacks down light not lit on touch pad	Check the float switch for operation. Check the float switch for proper orientation, see label on tank of pump assembly for orientation (vertical tanks only). For fluid sensor and float switch ID chart use TIP sheet 82-L0512. For testing of horizontal fluid sensors or float switches use TIP sheet 82-L0511. For testing of vertical fluid sensor or float switches use TIP sheets 82-L0509 and 82-L0510. Check for continuity on brown wire from float switch to control. Check for ground to float on black wire.
Dump valve coil defective	Check coil for continuity, if none replace valve.
Dump valve defective	Replace valve.
Jack leg valve wire defective	While pushing the front or rear buttons check for +12vdc on the 8 pin connector at pin #5 (yellow), pin #6 (orange) and pin #7 (purple). See wiring diagram for jack leg valve designations. Check for continuity from control box to jack coil, if none replace wire
Jack leg valve ground wire defective	Check for ground at the coil terminal black or red wire, repair if necessary
Jack leg valve coil defective	Check coil for continuity, if none replace leg valve
Jack valve faulty	Swap with another jack valve that is working correctly and test. Replace cartridge valve
Shunt valve clogged	Remove corresponding hose fitting on manifold to gain access to shunt valve. Clean valve passages with solvent and compressed air.
Shunt valve spring damaged	Replace spring.
Hose damaged	Replace kinked or damaged hose (damage may not be visible externally)

### ANY JACK RETRACTS VERY SLOWLY

PROBABLE CAUSE	CORRECTIVE ACTION
Lubricate the jack	While the jacks are extended down spray the chrome rod with silicone spray. If the jacks have a zerk fitting in the bottom collar of the jack assembly apply all purpose lithium grease. Three pumps with a manual grease gun are recommended. Retract the jacks and then extend the jacks. Lubricate the jacks again as above. Repeat this process 2 more times.
Jack rod guide is rusted or dirty	Clean the chrome rod and grease rod guide if equipped with grease fittings. Otherwise lubricate with silicone fluid as described above. It may be necessary to reseal jack or replace.
Broken jack spring(s)	Replace jack spring (see TIP sheet 34 and TIP sheet 82-L0505).
Shunt valve clogged	Remove corresponding hose fitting on manifold to gain access to shunt valve. Clean valve passages with solvent and compressed air.
Shunt valve spring damaged	Replace spring.
Hose damaged	Replace kinked or damaged hose (damage may not be visible externally).
Internal failure within jack	Rebuild / replace components of jack as necessary.

### ANY JACK RETRACTS WITH NO POWER, WITH POSSIBLE POPPING SOUND

PROBABLE CAUSE	CORRECTIVE ACTION
Air in system	Check for vertical coil in hoses. Remove the vertical coil if present then fully extend all the jacks and retract fully. Repeat this for 4 cycles waiting a few minutes between cycles, check fluid level in between cycles and refill tank as necessary (see TIP sheet 140).
Lubricate the jack	While the jacks are extended down spray the chrome rod with silicone spray. If the jacks have a zerk fitting in the bottom collar of the jack assembly apply all purpose lithium grease. Three pumps with a manual grease gun are recommended. Retract the jacks and then extend the jacks. Lubricate the jacks again as above. Repeat this process 2 more times.
Jack legs create popping sound	Due to changes in temperature, expanding and contracting of fluid will magnify the problem of popping jacks; see the recommended hydraulic fluid for cold operating weather.
Contaminated fluid	Replace fluid (see TIP sheet 140 and 141).
Leg valves stuck open	Remove leg valve, clean or replace.
Dump valve contaminated	Remove dump valve, clean or replace.
Dump valve stuck open	Replace valve.
All leg valves and dump valve stuck open	Replace all the valves.

<b>JACKS DOWN LIGHT ON TOUCH PAD WILL NOT LIGHT WITH JACKS EXTENDED</b>	
<b>PROBABLE CAUSE</b>	<b>CORRECTIVE ACTION</b>
Fluid sensor faulty	Refer to TIP sheet 82-L0512 for identifying the float sensor and float switch. To test horizontal fluid sensors or float switches use TIP sheet 82-L0511. To test vertical fluid sensor or float switches use TIP sheet 82-L0509 and 82-L0510.
Harness wire faulty	Check for ground at fluid sensor wires. The brown wire to pin #2 at controller should read ground when jacks are down. The other fluid sensor wire should read ground at all times.
Fluid sensor miss adjusted	See TIP sheet 30, 54 or 81 for fluid sensor orientation on vertical tanks only.
Open circuit on the brown sensor wire	Check for continuity on the brown wire between the float sensor and pin #2 of the 8 pin connector at controller. If none replace wire.
Defective light on touch pad	Apply +12vdc to pin #2 of the 8 pin connector with the key on. Turn on touch pad, if no light then replace the touch pad.

<b>JACKS DOWN LIGHT ON TOUCH PAD WILL NOT EXTINGUISH WITH JACKS RETRACTED</b>	
<b>PROBABLE CAUSE</b>	<b>CORRECTIVE ACTION</b>
Low fluid level	Fill tank with automatic transmission fluid see (TIP sheet 140).
Fluid sensor miss adjusted	See TIP sheet 30, 54 or 81 for fluid sensor orientation on vertical tanks only.
Fluid sensor faulty	Refer to TIP sheet 82-L0512 for identifying the float sensor and float switch. To test horizontal fluid sensors or float switches use TIP sheet 82-L0511. To test vertical fluid sensor or float switches use TIP sheet 82-L0509 and 82-L0510.
Open circuit on the brown sensor wire	Check for continuity on the brown wire between the float sensor and pin #2 of the 8 pin connector at controller. If none replace wire.

<b>JACKS DOWN LIGHT AND ALARM WILL GO ON WHILE DRIVING, JACKS RETRACTED</b>	
<b>PROBABLE CAUSE</b>	<b>CORRECTIVE ACTION</b>
Low fluid level	Fill tank with automatic transmission fluid see (TIP sheet 140).
Fluid sensor miss adjusted	See tip sheet 30, 54 or 81 for fluid sensor orientation on vertical tanks only.
Float sensor faulty	Refer to TIP sheet 82-L0512 for identifying the float sensor and float switch. To test horizontal fluid sensors or float switches use TIP sheet 82-L0511. To test vertical fluid sensor or float switches use TIP sheet 82-L0509 and 82-L0510.
Short in harness	Check float switch wires for open circuit.

<b>SYSTEM LEVELS BUT RETRACTS WHEN KEY IS TURNED OFF</b>	
<b>PROBABLE CAUSE</b>	<b>CORRECTIVE ACTION</b>
Improper wiring to 6 pin harness.	See TIP sheets 195, 196, 197, 199, 200, 204, 205.

<b>SYSTEM DROPS DOWN SLIGHTLY AS KEY IS SHUT OFF</b>	
<b>PROBABLE CAUSE</b>	<b>CORRECTIVE ACTION</b>
Improper wiring to 6 pin harness.	See TIP sheets 195, 196, 197, 199, 200, 204, 205.

<b>LEVELING SYSTEM RETRACTS WHEN KEY IS PUT INTO ACC POSITION</b>	
<b>PROBABLE CAUSE</b>	<b>CORRECTIVE ACTION</b>
Improper wiring to 6 pin harness	See TIP sheets 195, 196, 197, 199, 200, 204, 205.

<b>SYSTEM WILL NOT AUTO RETRACT WHEN THE CHASSIS IS PUT INTO DRIVE</b>	
<b>PROBABLE CAUSE</b>	<b>CORRECTIVE ACTION</b>
Improper wiring to 6 pin harness.	See TIP sheets 195, 196, 197, 199, 200, 204, 205.
Neutral safety switch wires shorted	At the 6 pin connector (see wiring diagram): Check for voltage at pin #6. If it has +12vdc verify pin #2 at the 6 pin connector also has +12vdc. If pin #2 is ground, ground pin #6 at the 6 pin. If the control then operates, repair or replace wires or neutral safety switch.

**SYSTEM DOES NOT LEVEL TO CORRECT LEVEL POSITION**

<b>PROBABLE CAUSE</b>	<b>CORRECTIVE ACTION</b>
Controller needs to be recalibrated	See TIP sheet 147( leveling with bubble level) TIP sheet 152 (Semi-automatic) TIP sheet 153 (Automatic) For control boxes with part number 1010001002 see TIP sheet 12003 For control boxes with part number 1010001284 see TIP sheet 12004.
Control box is not mounted in proper orientation	Arrow on control box must point forward. Mounting flange for control box must be on top, with wire harnesses coming out the bottom.
Low voltage at control box	Check between pin #8 (power) and pin #1 (ground) of the 8 pin connector. For what specific voltage should be, see TIP sheet 3010002151.
Hoses plumbed wrong at jacks	Verify front hoses are plumbed from front jacks to F and F1 on manifold of hydraulic pump assembly. Verify curbside rear hose is plumbed to CR at manifold at pump assembly. Verify that roadside rear jack is plumbed to RR at manifold at pump assembly.
Hoses plumbed wrong at pump assembly	Check valve block to make sure that the front hoses are plumbed to F and F1, CR is to curbside rear hose connector and RR to roadside rear hose connector.
Valve coils wired incorrectly	See wiring diagram for part location and color wire.
Harness pinned incorrectly	See wiring diagram for pin location and color of wire on harness.
Faulty control	If previous causes and actions do not apply replace control

**TOUCH PAD LIGHTS ARE FLASHING**

<b>PROBABLE CAUSE</b>	<b>CORRECTIVE ACTION</b>
Possible trouble code being displayed	See TIP sheet 184 for trouble codes and corrections.
Jacks are still down partially	Press the retract all jacks button to allow jacks to fully retract.
Coach is in emergency retract mode	Fluid low, see tip sheet 140 Fluid sensor is miss adjusted. See tip sheet 30, 54 or 81 for fluid sensor orientation on vertical tanks only.

**SYSTEM TURNS ON BUT TURNS OFF AS SOON AS A BUTTON IS PUSHED**

<b>PROBABLE CAUSE</b>	<b>CORRECTIVE ACTION</b>
Low system voltage	Voltage must remain above 12vdc while in operation. Check battery condition and connections.

**TOUCH PAD LIGHTS ARE ON SOLID**

<b>PROBABLE CAUSE</b>	<b>CORRECTIVE ACTION</b>
Control Box is defective	Replace the control box.

**ADDITIONAL REFERENCE PUBLICATIONS LOCATED AT**  
**[WWW.POWERGEARUS.COM](http://WWW.POWERGEARUS.COM)**

<b><u>Document #</u></b>	<b><u>Tip Sheet#</u></b>	<b><u>Description</u></b>
81-1217	Tip Sheet 34	Spring Replacement Kit
81-1218	Tip Sheet 35	Valve Block Assembly Replacement
81-1220	Tip Sheet 37 System Jacks	Procedure and Specification for installation of Power Gear Leveling
81-1219	Tip Sheet 38	Leg Cartridge / Solenoid Replacement
81-1236	Tip Sheet 48	Adequate Ground Assurance for Power Gear RV Systems
81-1243	Tip Sheet 54	Fluid Sensor Replacement Procedure
81-1290	Tip Sheet 76	Starter Solenoid Torque Specifications
81-1298	Tip Sheet 81	Fluid Sensor Replacement Procedure
81-1303	Tip Sheet 85	Leg Coil and Cartridge And / Or Dump Valve Coil and Cartridge Replacement
82-L0122	Tip Sheet 139	Power Gear Hydraulics System Fluid Recommendation
82-L0123	Tip Sheet 140	Oil Fill Procedure Leveling Systems
82-L0125	Tip Sheet 147	How to Level With a Bubble Level
82-L0316	Tip Sheet 152	Semi Automatic Leveling System Calibration
82-L0317	Tip Sheet 153	Automatic Leveling System Calibration
82-L0318	Tip Sheet 154	Reservoir Tank Replacement for kits 800036s, 800037s, and 800038s
82-L0329	Tip Sheet 165	Shunt Valve / Spring Replacement for Power Gear Pump Assembly
82-L0351	Tip Sheet 172	Lightweight Leveling Jacks, Bolt up Versions
82-L0353	Tip Sheet 178	Slow Retracting Rear Jacks On Power Gear Level Systems
82-E0265	Tip Sheet 180	Auxiliary Output (4pin) Pin Voltage Levels on Power Gear Leveling Controls
82-L0357	Tip Sheet 182	Damon Cross member Replacement
82-L0359	Tip Sheet 184	Power Gear Leveling Controls 500630 and 500674 Error Codes
	Tip Sheet 204	Manual Leveling Control Set-up Procedure
	Tip Sheet 215	Hydraulic Pump Diagnosis
	Tip Sheet 216	Hydraulic Pump Motor Diagnosis

**ADDITIONAL REFERENCE PUBLICATIONS LOCATED AT**  
**[WWW.POWERGEARUS.COM](http://WWW.POWERGEARUS.COM)**

<b>3010000042</b>	<b>Tip Sheet 218</b>	<b>Improvements to Power Gear Controls for Semi Automatic and Automatic Leveling Controls</b>
<b>12001</b>		<b>Manual Override for spring return Hydraulic Leveling</b>
<b>12002</b>		<b>Pump Harness Fuse Update for Spring Return Hydraulic Leveling</b>
<b>12003</b>		<b>Hydraulic Leveling and Calibration Procedure for Touch Pad #140-1226 and Control #1010001002</b>
<b>12004</b>		<b>Hydraulic Leveling and Calibration Procedure for Touch Pad #140-1226 and Control #1010001284</b>
<b>3010002151</b>		<b>Low Voltage Led Indication for Hydraulic and Electric Leveling</b>
<b>82-L0504</b>		<b>Hydraulic Hoses Used with Leveling Systems</b>
<b>82-L0508</b>		<b>Replacement Procedure for Float switch or Fluid Sensor on Horizontal Hydraulic Pump Tank</b>
<b>82-L0509</b>		<b>Testing Float Switches and Fluid Sensors Part #14-1085, 14-1101, 14-1106 in Vertical Hydraulic Pump Tank</b>
<b>82-L0510</b>		<b>Testing Vertical Float Switches</b>
<b>82-L0511</b>		<b>Testing Float switches or Fluid Sensors in Horizontal Hydraulic Pump Tank</b>
<b>82-L0512</b>		<b>Hydraulic Leveling Float Switch or Fluid Sensor ID Chart</b>