

# WIRING DIAGRAM

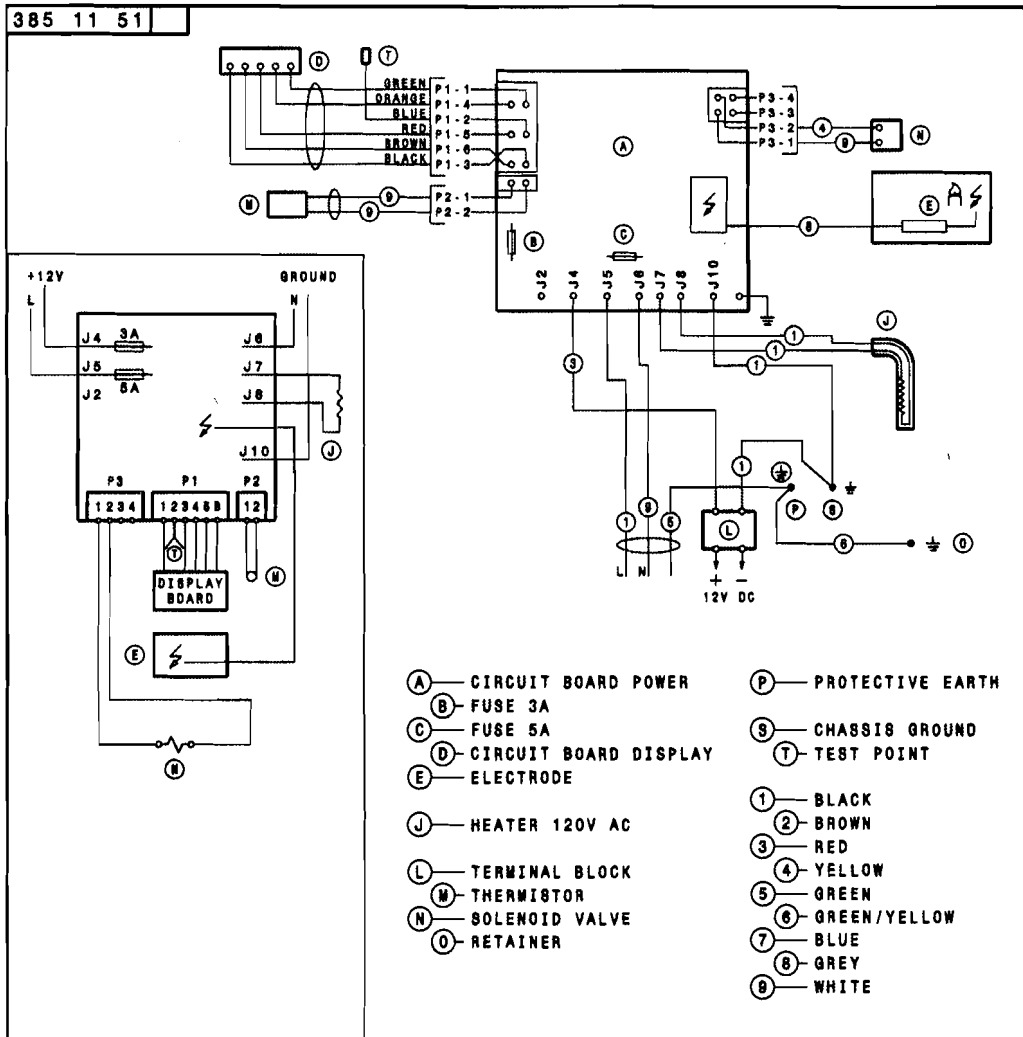

N38511510