

**NEA1402
NDA1402**
autodefrost**FOR YOUR SAFETY**

If you smell gas:

1. Open windows.
2. Don't touch electrical switches.
3. Extinguish any open flame.
4. Immediately call your gas supplier.

POUR VOTRE SÉCURITÉ

Si vous sentez une odeur de gaz:

1. Ouvrez les fenêtres.
2. Ne touchez à aucun interrupteur.
3. Éteignez toute flamme nue.
4. Avertissez immédiatement votre fournisseur de gaz.

FOR YOUR SAFETY

Do not store or use gasoline or other flammable vapors and liquids in the vicinity of this or any other appliance.

POUR VOTRE SÉCURITÉ

Ne pas entreposer ni utiliser de l'essence ni d'autres vapeurs ou liquides inflammables à proximité de cet appareil ou de tout autre appareil.

⚠ WARNING

Improper installation, adjustment, alteration, service or maintenance can cause injury or property damage. Refer to this manual. For assistance or additional information consult a qualified installer, service agency or the gas supplier.

⚠ AVERTISSEMENT

Une installation, un réglage, une modification, une réparation ou un entretien non conforme aux normes peut entraîner des blessures ou des dommages matériels. Lisez attentivement le mode d'emploi fourni avec l'appareil. Pour obtenir de l'aide ou des renseignements supplémentaires, consultez un installateur ou un service d'entretien qualifié ou le fournisseur de gaz.

USA

Service Office
Dometic Corporation
2320 Industrial Pkwy.
Elkhart, IN 46516
Phone: 574-294-2511

Corporate Office

2320 Industrial Parkway Elkhart, IN 46515

For Service Center Assistance

Call: 800-544-4881

CANADA

Dometic Corporation
46 Zatonski, Unit 3
Brantford, ON N3T 5L8
CANADA
Phone: 519-720-9578

This product is manufactured under license of
U.S. Patent Number 6.019,447

Patents pending

U.S. 10/619,675

U.S. 10/620,177

U.S. 10/758,174

U.S. 10/758,175

U.S. 10/760,564

U.S. 10/760,565

INTRODUCTION

Thank you for entrusting us to supply your new quality-guaranteed refrigerator which is to be used as a recreational device designed for storage of foods, frozen foods and making ice. Please, when the refrigerator is not in use as a recreational device, turn the system off and open the door(s).

This manual describes how to operate NEA1402 (all-electric) and NDA1402 (2-way operated). Read it carefully to ensure that you know how to operate the refrigerator safely and correctly. Be aware of possible safety hazards when seeing alert symbols on the refrigerator as well as in this manual. The manual should be kept and stay with the refrigerator if it is ever moved or change owners.

Servicing should be performed by qualified personnel only! Thus, the section regarding maintenance and service is intended for service personnel. For installation instructions, refer to the INSTALLATION MANUAL.

CONTENTS

REFRIGERATOR OVERVIEW _____	4	STORAGE COMPARTMENTS _____	11
Features	4	MAINTENANCE & SERVICE _____	13
Absorption cooling system	4	TROUBLESHOOTING _____	15
Automatic defrosting control system	4	Troubleshooting table	15
NDA1402 - Automatic energy selector system	4	Status messages	16
Using the control features	5	Call for service	17
OPERATING INSTRUCTIONS _____	6	Service mode	17
Start-up	6	APPENDIX A - SPARE PARTS _____	18
Settings	6	APPENDIX B - CONSUMER SUPPORT _____	19
Dispensers	7	APPENDIX C - DOMETIC WARRANTY &	
Ice maker	8	MAINTENANCE SCHEDULE _____	20
STORAGE PROCEDURE / WINTER OPERATION _____	9		
Getting the refrigerator ready for storage	9		
Draining the ice maker	9		

SYMBOLS

The following symbols are used throughout the manual:



Indicates a potentially hazardous situation, which, if not avoided, could result in death or serious injury.



Indicates a potentially hazardous situation, which, if not avoided, may result in minor or moderate injury.



Used without the safety alert symbol indicates, a potentially hazardous situation which, if not avoided may result in property damage.



Information



Step-by-step instructions

REFRIGERATOR OVERVIEW

FEATURES

- This side-by-side refrigerator-freezer has two compartments with separate doors. The left one is a frozen food compartment (the freezer) and the right one is a fresh food compartment (the fridge). Both compartments have automatic defrosting and independent temperature controls.
- **NDA1402:** 2-way power option. The cooling system may use either 120V AC or LP gas as energy source for the cooling. Energy selection is made either automatically or manually (forced to gas).
NEA1402: All-electric operation.
- Models equipped with ice dispenser or both ice and water dispenser: In order to make serving water and ice easier, the refrigerator is equipped with a dispenser for ice cubes and chilled water through the door. Without having to open the freezer it provides water as well as crushed or cubed ice right into the cup.
- Climate control cooling system.
- Digital controls show current temps in both compartments.
- Vacuum insulated panels increase interior storage space.
- Automatic front frame heater prevents condensation from forming on exterior cabinet.
- Flexible storage options.

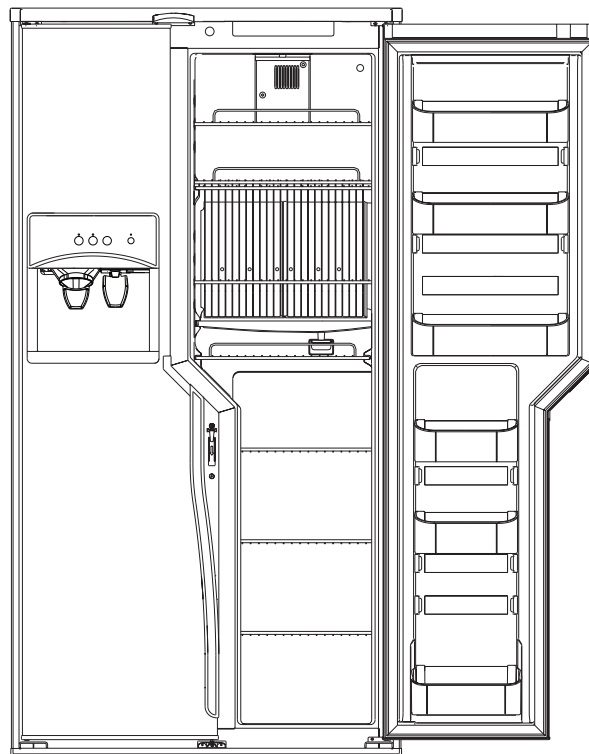

Model shown with ice and water dispenser

ABSORPTION COOLING SYSTEM

In an absorption refrigerator system, ammonia is liquefied in the finned condenser coil at the top rear of the refrigerator. The liquid ammonia then flows into the evaporator (inside the freezer section) and is exposed to a circulating flow of hydrogen gas, which causes the ammonia to evaporate, creating a cold condition in the freezer.



When starting this refrigerator for the very first time, the cooling cycle may require up to four hours of running time before the cooling unit is fully operational.

The tubing in the evaporator section is specifically sloped to provide a continuous movement of liquid ammonia, flowing downward by gravity through this section.

LEVELING THE REFRIGERATOR

Leveling is one of the requirements for proper operation with absorption refrigerators. To ensure proper leveling the vehicle needs to be leveled so it is comfortable to live in (no noticeable sloping of floor or walls).

Any time the vehicle is parked for several hours with the refrigerator operating, the vehicle should be leveled to prevent this loss of cooling.

If the refrigerator is operated when it is not level and the vehicle is not moving, liquid ammonia will accumulate in sections of the evaporator tubing. This will slow the circulation of hydrogen and ammonia gas, or in severe cases, completely block it, resulting in a loss of cooling.

When the vehicle is moving, the leveling is not critical, as the rolling and pitching movement of the vehicle will pass to either side of level, keeping the liquid ammonia from accumulating in the evaporator tubing.

AUTOMATIC DEFROSTING CONTROL SYSTEM

This refrigerator is equipped with an automatic defrosting control system. The defrost system will automatically carry out defrost in frozen food and fresh food compartment once per 24 hours. To be able to control the performance of the defrost intervals the system is equipped with a built in defrost timer. The timer has to be set to local or Central American time at the very first start up of the refrigerator or when the 12V DC supply has been disconnected for a longer period of time. A message on the LED display panel will alert when the defrost timer needs to be set.

NDA1402 - AUTOMATIC ENERGY SELECTOR SYSTEM

This refrigerator is equipped with an automatic energy selector system which automatically selects the most suitable energy source that is available, either 120 V AC or LP gas operation. The system can be set by the user to be fully automatic, or to operate on LP gas only.

⚠ WARNING

FIRE OR EXPLOSION HAZARD. When refueling or parked near gasoline pumps, shut off all LP gas appliances. Failure to heed this warning could cause a fire or explosion resulting in death or severe personal injury.

REFRIGERATOR OVERVIEW

USING THE CONTROL FEATURES

NEA1402

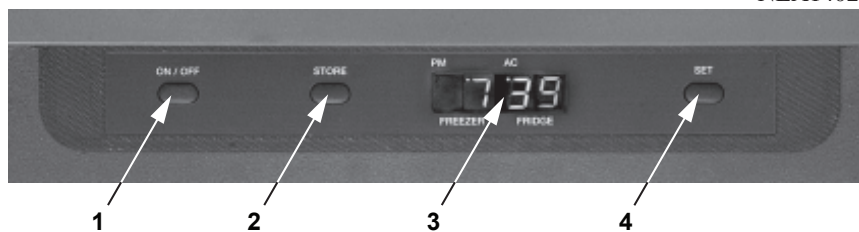

NDA1402

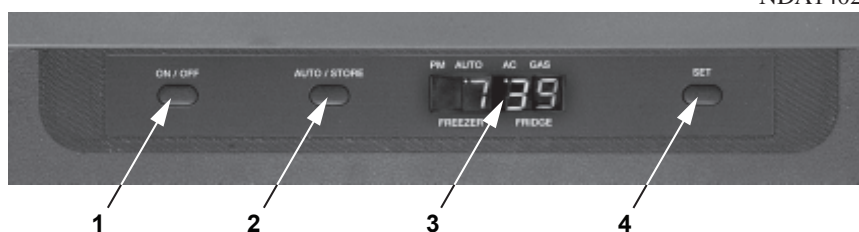

CONTROL PANEL

- 1. ON/OFF key.**
Press this button to turn the refrigerator on and off.
- 2. STORE key (NEA1402)**
AUTO/STORE key (NDA1402)
Combined energy mode selection and store key.
- 3. LED display panel**
- 4. SET key**
Combined temperature range and defrost timer adjustment.

LED DISPLAY PANEL

The LED panel displays preferably temperatures in the refrigerator, current modes of operation and other useful status messages.

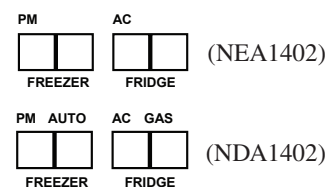

The displayed temperature values reflect the storage temperatures of the food in the two compartments. A delay function prevents rapid changes due to door openings etc.

Panel indications:

- Actual temperature of food in frozen food compartment.
- Actual temperature of food in fresh food compartment.
- AUTO mode indication (NDA1402)
- AC operation indication.
- GAS operation indication (NDA1402)
- Thermostat setting indication (temporary during setting).
- Defrost timer/ PM indication (temporary during setting).
- Various status and error messages.

Store function

When setting the defrost timer as well as the thermostat, the desired setting is stored automatically after 5 sec. of inactivity or by pressing the STORE key.

OPERATING INSTRUCTIONS

START-UP

NEA1402

 Turn on the refrigerator by pressing the **ON/OFF** key.

NDA1402

⚠ WARNING

FIRE HAZARD. Before lighting the gas burner, after that the RV has not been used for some time, please check that the gas path between the burner jet and the burner tube has not been obstructed. Failure to heed this warning could cause a fire resulting in personal injury.

-  1. Before turning on the refrigerator, please verify that all the manual gas valves, including the manual shut off valve, are in the ON position.
2. Turn on the refrigerator by pressing the **ON/OFF** key.

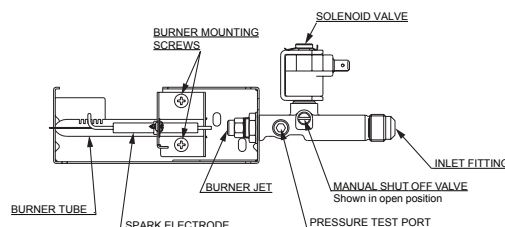

SETTINGS

SET DEFROST TIMER

NEA1402

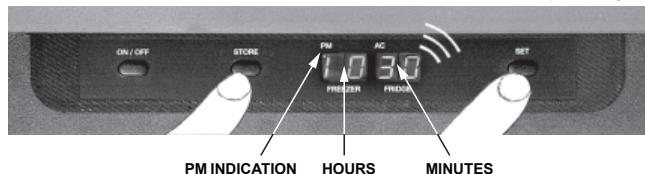

NDA1402

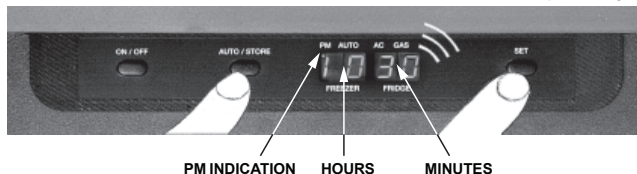

NOTE! The defrost timer must be set in order for the automatic defrosting system to work properly. For further information, see REFRIGERATOR OVERVIEW > AUTOMATIC DEFROSTING SYSTEM. If the defrost timer has to be set, the LED panel will show flashing horizontal bars " -- -- ".

-  1. To enter **TIMER MODE** keep **SET** key pressed until figures flash on the LED panel. (Hours are to the left and minutes to the right.)
2. Press the **SET** key to adjust to local or Central American time. PM/AM should also be set here.
3. Store each setting by pressing **AUTO** key (NEA 1402) - **AUTO/STORE** key (NDA 1402) - or - use the automatic store function (wait 5 sec.).

SET THERMOSTAT RANGE

NDA1402 temperature control

The freezer and the fresh food compartment temperatures are controlled separately and independently of each other, based on the actual air temperature in each compartment. The compartment temperatures will be the same regardless of ambient temperature or setting in the other compartment.

- The freezer setting is pre-set (can not be changed) to be approx. 0F (-18°C) when running on AC. If running on GAS the pre-set temperature is approx. 7F (-14°C).
- The fresh food compartment can be set in 5 different positions (1-5) where 5 is the coldest setting which give a fresh food temperature of approx. 33F (0°C). Setting 3 gives a temperature of approx. 37F (3°C).

NEA1402



NDA1402



-  1. Press the **SET** key to set the thermostat. Thermostat range is 1 to 5, where 5 represent the coldest compartment temperature.
2. Press the **STORE** key to store or use the automatic store function (wait 5 sec.).

OPERATING INSTRUCTIONS

MANUAL DEFROST

NEA1402



NDA1402



The refrigerator can be set to defrost at any time. Usually a defrost cycle takes about 1 hour but is depending on the amount of frost and could therefore vary from time to time.

1. Switch off the refrigerator with the **ON/OFF** key.
2. Press and hold the **AUTO** key (NEA 1402) - **AUTO/STORE** key (NDA 1402). Then, press the **ON/OFF** key. "dE Fr" is displayed.

NDA1402 - SELECT ENERGY MODE OF OPERATION



Current mode of operation and energy source (AC or GAS) is indicated by a dot on the LED panel.

1. Press **AUTO/STORE** key to select AUTO mode operation or lock up to LP-gas mode operation only.

DISPENSERS



Information applicable for models equipped with dispenser(s).

ICE DISPENSER

For a refrigerator to provide ice through the door, the ice maker first dumps the ice it produces into a large bin. To request ice at the door, select Cube or Crush and then press the lever. This will activate a switch which turns on a motor that rotates the auger. When the auger rotates, it pushes ice out of the bin, through a chute right into the glass. To stop dispensing, pull glass away from dispensing arm before the glass is full. Allow ice chute to clear before removing glass.

WATER DISPENSER

The water dispenser works much like the ice dispenser. To request water at the door, simply press the lever. This will activate a switch which turns on an electric water valve at the back of the refrigerator. Water will flow through a separate tube right into the glass.

LOCK OUT FEATURE

The ice dispensing system can be locked out to prevent unwanted use.

• Lock Out

To lock out, press the "Padlock" pad for 3-5 seconds until the RED light above the Padlock comes on.

• Unlock

To unlock, press the "Padlock" pad for 3-5 seconds until the RED light above the Padlock goes out.

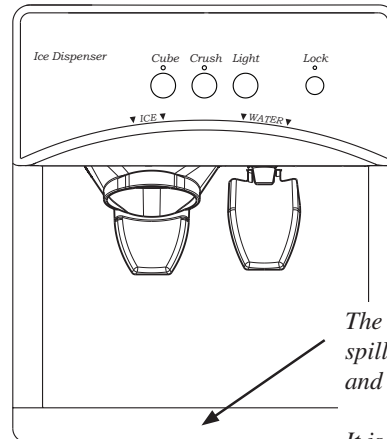

The drip tray catches small spills. The tray is removable and dishwasher safe.

It is not a drain; DO NOT pour water directly into this area!

DISPENSER LIGHT

The light can be turned on and off by pressing the light touch pad. The light will illuminate the dispenser area. The light will also turn on automatically when the ice is dispensed.

AUTOMATIC POWER SUPPLY SWITCH OFF

For safety reason, when opening the freezer door, the ice dispensing and ice maker system will automatically shut off its function. Closing the freezer automatically resume operation of ice dispensing and ice maker operation.

OPERATING INSTRUCTIONS

ICE MAKER

HOW IT WORKS

Before the ice maker can operate, make sure that the:

- Refrigerator is connected to 120 V AC.
- Water valve supplying the refrigerator is turned on.
- Ice level bail arm is in its fully down position.

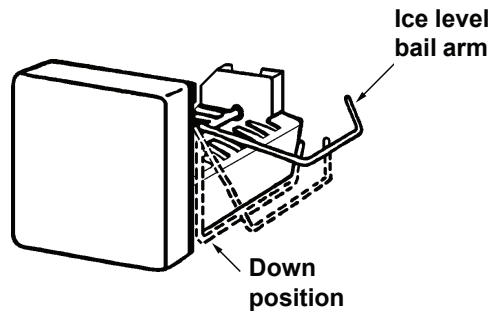

When the ice maker thermostat senses the preset temperature for the ejection of the ice cubes, the fingers will start to rotate, dumping any ice cubes and filling the mold with water. When the storage container is full, the bail arm will come in contact with the ice cubes. The bail arm cannot return to the full down position and the ice production is stopped until the bin is emptied, or ice cubes are removed.

When on the road, the water in the icemaker might, depending on road conditions, splash out of the mold. To avoid splashing, the mold needs to be either empty - or - the water in the mold must be frozen.

WATER SUPPLY

The water supply system must have a minimum pressure of 15 pounds per square inch gauge (psig). Use a 1/4" diameter water line to the water valve at the rear of the refrigerator. The water line must have a manual shutoff valve placed where it is easily accessible.

The maximum water level is represented by a thin line. It is essential that the water level does not exceed this line!

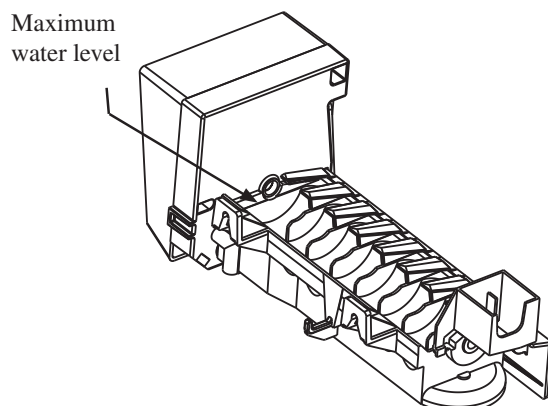

If necessary change the water flow by adjusting the water supply, see the step-by-step instruction in ADJUSTING THE SIZE OF CUBES.

ADJUSTING THE SIZE OF CUBES

The first container of ice cubes should be dumped if the water system has been winterized or not used for several weeks.

Note that if the ice maker have been cleaned and drained, no ice cubes will be dumped into the bin during the first cycle.

The first few cycles may produce small cubes due to air trapped in the water lines. Once the ice maker has run through several cycles and if the cubes are too small or sticking together, adjustment is necessary on the amount of water entering the mold.

To adjust the size of cubes, follow these steps:

1. Remove the protective cover from the ice maker mechanism.
2. Locate the adjusting screw under the protective cover.

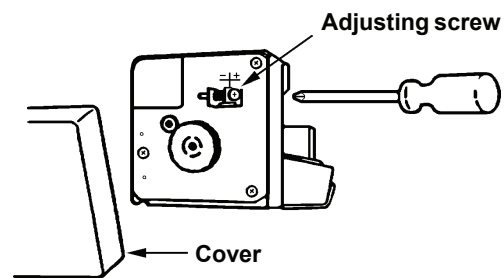

3. To increase the size of cubes, turn the screw counter clockwise. To decrease the cube size or if the cubes are stuck together, turn the screw clockwise.

NOTE! To prevent overfilling, DO NOT turn the adjustment screw more than one revolution at a time. Allow the ice maker to cycle several times before another adjustment is made. Be sure to replace the protective cover on the cycle after the adjustments are complete.

STORAGE PROCEDURE / WINTER OPERATION

GETTING THE REFRIGERATOR READY FOR STORAGE

The refrigerator is equipped with a heater tape wrapped around the water solenoid valve and outlet water tube. During cold weather operation below 32°F/0°C the automatic temperature switch will turn the heater tape on automatically.

NOTE! The refrigerator automatic heater tape doesn't work when the refrigerator is shut off.

Summer short-time storage

The coach's Air Conditioner (A/C) is recommended to be left on to prevent/reduce condensation. If the A/C is switched off, while leaving the refrigerator on, the air humidity will increase and form condensation on the outside of the refrigerator.

If the refrigerator is on, the A/C should be on. Consequently, if the A/C cannot be left on, please shut off the refrigerator as well.

Should the weather get cold during a period of short-term storage, follow the procedure for longer-term storage as described below.

Long-term storage

If the RV will not be in use for an extended period of time or put into storage:

- Drain the RV water system.
- Disconnect the water lines from the inlet and outlet sides of the water valve. Drain the lines into a cup and allow the lines to dry.
- The ice maker should be drained and dried, see DRAINING THE ICE MAKER.
- Using a lukewarm soda solution, clean the interior liner of the refrigerator. Clean the finned evaporator, ice trays and shelves. Use warm water only and never strong chemicals or abrasives since these can damage the protective surfaces.
- Leave the doors ajar.

DRAINING THE ICE MAKER

If the RV is in storage and the refrigerator or the DC power is turned "OFF" there will be no 12V DC present to operate the heat tape; therefore, it will be necessary to drain and dry the ice maker. This will prevent water from freezing in the solenoid valve or becoming stale and producing bad tasting ice.

If the temperatures are expected to reach or exceed 0°F/-18°C the ice maker must be drained to prevent component damage and leaks.

NOTE! Water, compressed air and AC power are required to drain the ice maker. Draining of the ice maker must be done by a qualified service technician.

To drain the ice maker, follow these steps:

1. Shut off water supply valve to the ice maker.
2. Place a shallow pan under water solenoid valve.
3. Remove the hose from the inlet fitting to the water solenoid valve.
4. Drain water from the supply line.

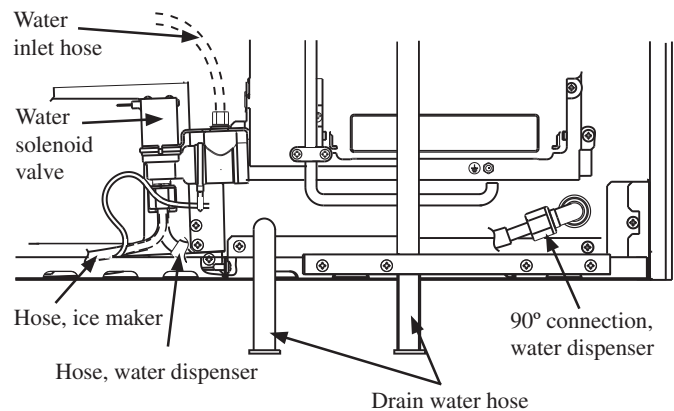

Rearview of models equipped with ice & water dispenser

CAUTION

Do not use:

- A knife or an ice pick, or other sharp tools to remove frost from the freezer shelves. It can create a leak in the ammonia system.
- A hot air blower. Permanent damage could result from warping the metal or plastic parts.

STORAGE PROCEDURE / WINTER OPERATION

- Remove the plastic nut(s) and water line(s) from outlet side of the water solenoid valve.

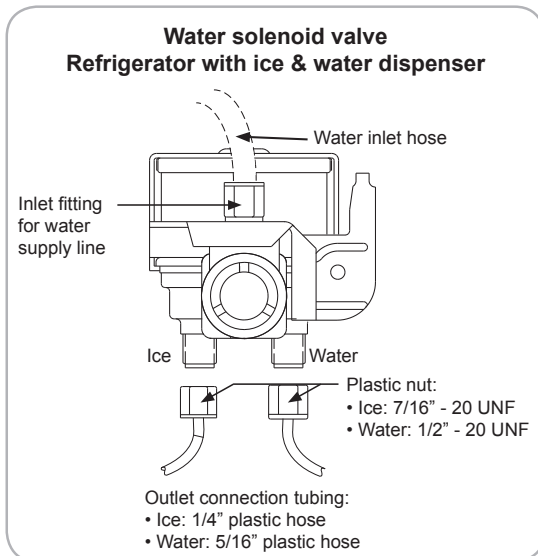
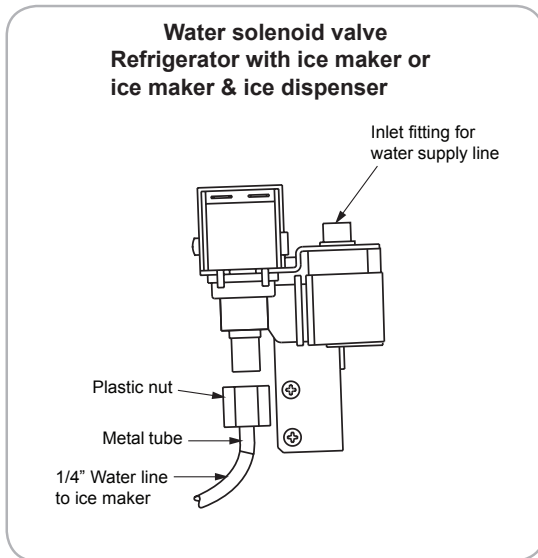

- Drain water from the line.
- Connect compressed air onto the inlet fitting of the water solenoid valve.
- Apply AC power to the solenoid valve by forcing the ice maker mold assembly through several harvest cycles. Note! Damage to the solenoid can occur if AC power is applied for more than 20 seconds.
- Remove the plastic cover from the mold assembly. The bail arm must be in the down ("ON") position.

- Start the harvest cycle with a flat blade screw driver inserted into the center of the small gear.

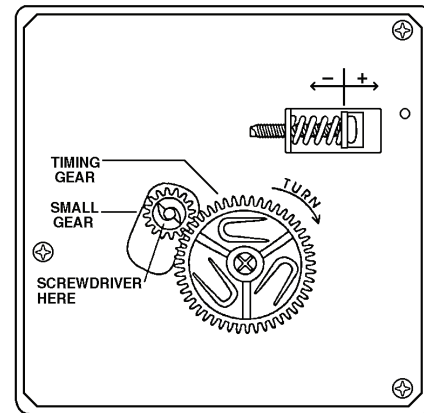

- Turn the gear counter clockwise, when the hold switch closes, the mold assembly will continue to operate through the harvest cycle. During the water fill sequence of the harvest cycle the compressed air will blow out the water trapped in the solenoid valve. Up to 20 PSIG air pressure can be used to clear the solenoid valve.
- Repeat the harvest cycle operation several times.
- Refrigerator with ice and water dispenser.
 - Clear the water part of the solenoid valve. Press the lever to open the valve and then, apply compressed air to blow out the water trapped in this part of the valve.
 - Blow out the water from the water dispenser hose. Use compressed air as shown in the figure below.

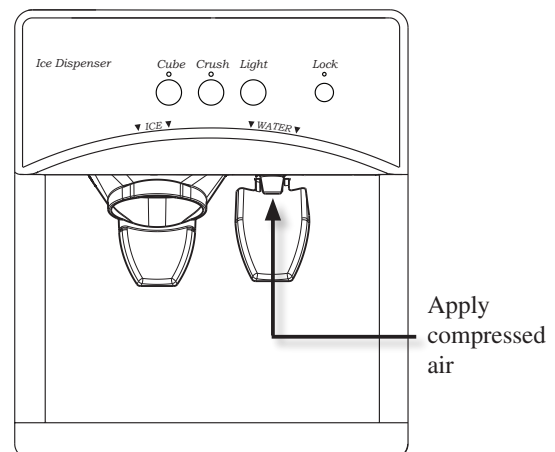

- Reconnect and tighten the lines on water solenoid valve. Make sure that the metal tube is in the plastic water line to the ice maker.
- Leave the water supply turned off until temperatures are above 0°F/-18°C.
- Dry the ice maker mold assembly with a soft cloth.
- Place bail arm in the "UP/OFF" position.

STORAGE COMPARTMENTS

⚠ WARNING

EXPLOSION HAZARD. Never store explosive substances in the refrigerator, such as cigarette lighter fuel, gasoline, ether or the like. Failure to heed this warning could cause an explosion resulting in death or severe personal injury.

FOOD STORAGE COMPARTMENT

Total refrigerated volume: 14.0 cu.ft.

The food storage compartment is completely closed and unventilated, which is necessary to maintain the required low temperature for food storage. Consequently, foods having a strong odor or those that absorb odors easily should be covered. Vegetables, salads etc. should be covered to retain their crispness.

The coldest positions in the refrigerator are under the cooling fins and at the bottom of the refrigerator. The warmer areas are on the upper door shelves. This should be considered when placing different types of food in the refrigerator.

When the refrigerator is heavily loaded, it will take a longer time to lower the temperature; therefore, to get maximum efficiency the refrigerator and food items should be precooled prior to loading. The shelves should not be covered with paper or plastic, and the food items should be arranged so air can circulate freely. The food must not block the circulation of air.

If you need more space in the refrigerator you can lift up the front of the second shelf from the top and push the shelf in, the shelf will fall down against the finned evaporator. This shelf cannot be relocated to a different position within the refrigerator. The middle shelf is a sliding shelf, to slide out grasp the front of the shelf and pull forward. Push the shelf in to return to original position. This shelf cannot be relocated to a different position within the refrigerator. The lower door shelf is designed for large containers or bottles (1/2-gallon milk or juice).

FROZEN FOOD STORAGE COMPARTMENT

This compartment is not designed for deep or quick freezing of food. Meat or fish, whether raw or prepared, can be stored in the frozen food storage compartment provided they are precooled first in the refrigerator. They can be stored about three times longer in the frozen food compartment as compared to the fresh food compartment.

To prevent food from drying out, keep it in covered dishes, containers, plastic bags or wrapped in aluminum foil.

The freezer compartment has two sliding wire baskets for more convenient access to the frozen foods.

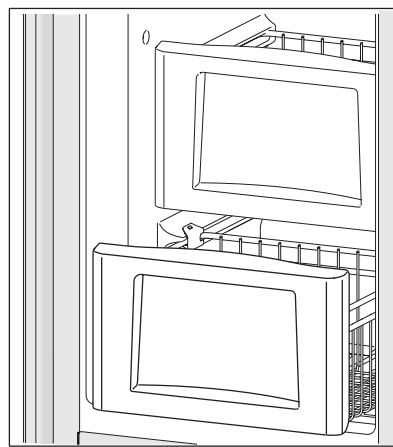

The freezer door has three wire door baskets for frozen food items, such as bagged vegetables.

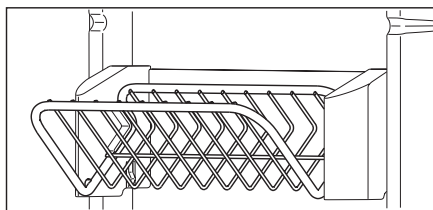

STORAGE COMPARTMENTS

POSITIONING OF SHELVES

1 /

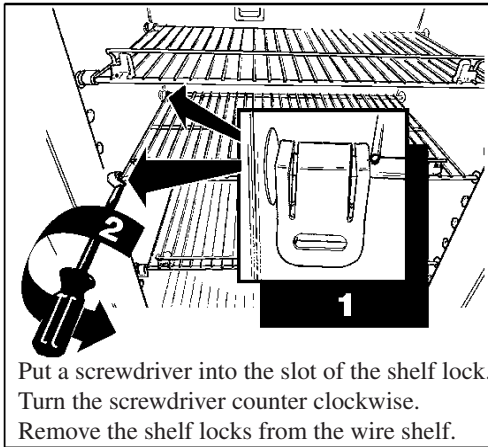

2 /

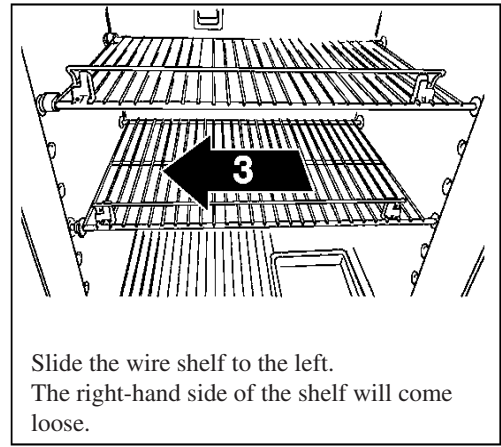

3 /

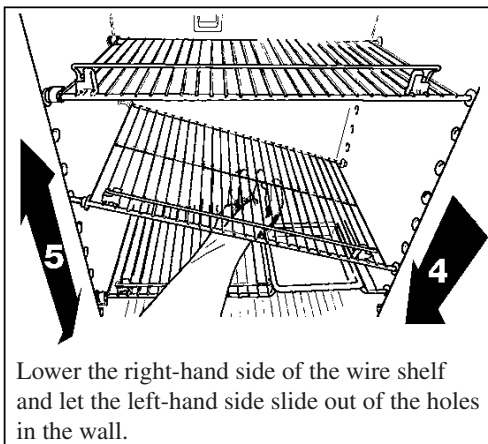

4 /

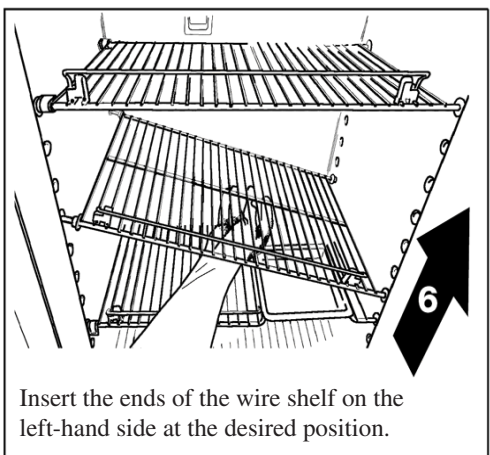

5 /

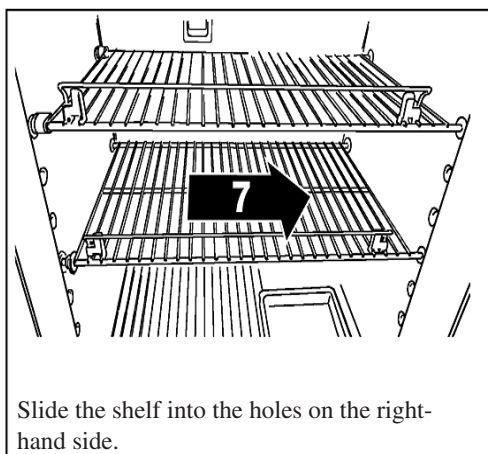

6 /

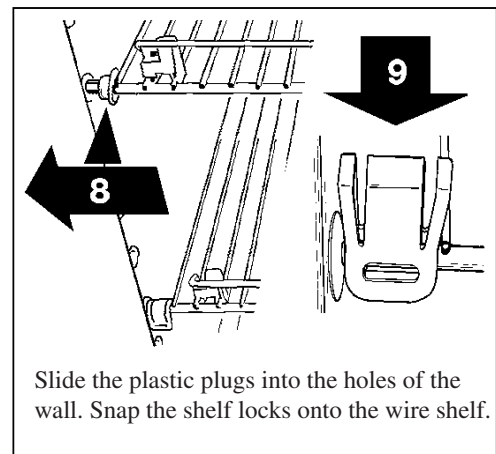

MAINTENANCE & SERVICE

- Always keep the food compartment and the freezer clean.
- If the refrigerator will not be in operation for a period of weeks it should be emptied, defrosted, cleaned and the doors left ajar, see STORAGE PROCEDURE / WINTER OPERATION.
- Periodic inspection, cleaning and maintenance of the refrigerator is recommended.
 - Make sure the area behind the refrigerator is clear and free from combustible material, gasoline and other flammable vapors or liquids.
 - Dust off the coils on the back of the refrigerator (use a soft bristled brush).
 - Make sure the upper and lower vents are free from any obstructions.

CAUTION

If your refrigerator stops cooling, immediately turn the refrigerator off and see a Dometic dealer.

NDA1402

- Check the burner flame for proper appearance. The flame should be light blue.
- A qualified service technician should, at least once a year, inspect the connections, the control system, the LP gas pressure and the flue baffle, see PERIODIC MAINTENANCE.



The following instructions are applicable for NDA1402. The procedures described in PERIODIC MAINTENANCE are to be performed by service personnel only.

PERIODIC MAINTENANCE

CHECKING THE CONNECTIONS



1. Check all connections in the LP gas system (at the back of the refrigerator) for gas leaks. The LP gas supply must be turned on.
2. Apply a non-corrosive bubble solution to all LP gas connections. The appearance of bubbles indicates a leak and should be repaired *immediately* by a qualified serviceman.

WARNING

EXPLOSION HAZARD. Never use an open flame to check for gas leaks. Failure to heed this warning could cause an explosion resulting in death or severe personal injury.

CHECKING THE LP GAS PRESSURE

The LP gas pressure should be checked and the main regulator readjusted if pressure is incorrect. The correct operating pressure is 11 inches of water column. Measure the LP gas pressure at the test port, just ahead of the burner jet.

GAS EQUIPMENT ASSEMBLY

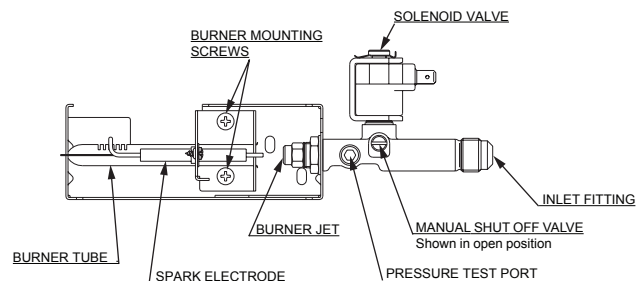

MAINTENANCE & SERVICE

CLEANING THE FLUE AND BURNER

Inspect the flue baffle. It should be reasonably clean and free of soot. Heavy soot formation indicates improper functioning of the burner.

To clean the flue and burner, follow these steps:

1. Unplug the refrigerator power cord from the 120V AC outlet.
2. Disconnect/shut off the 12V DC power to the refrigerator.
3. Turn the manual shutoff valve to OFF.
4. In turn, remove the:
 - Cover from the burner housing.
 - Burner mounting screw and burner assembly.
 - Wire and flue baffle from the top of flue tube.
5. Using a flue brush, clean the flue from the top. Blowing compressed air into the flue will not properly clean soot and scale out of the flue tube.
6. Replace the flue baffle.
7. Clean the burner tube with a brush. Blow out the burner with compressed air.
8. Before removing the burner jet, clean burner area of soot and scale that fell out of flue tube.
9. Remove the burner jet.
10. Soak the jet in wood alcohol and blow it out with compressed air.

⚠ WARNING

FIRE HAZARD. Do not use a wire or pin when cleaning the burner jet as damage can occur to the precision opening. Failure to heed this warning could cause fire resulting in personal injury.

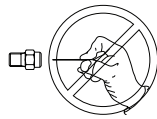

11. Reinstall and tighten the burner jet.
12. Carefully reinstall the burner. Make sure the end of the burner fits into the slot on the burner bracket and that the slots are centered under the flue tube.

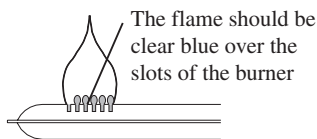

13. Check the electrode for proper location and gap.

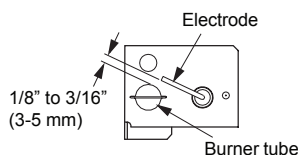

14. Turn on the manual gas shutoff valve. Check all fittings for leaks with soapy water.
15. Connect the 120V power cord to the outlet. Reconnect/turn on the 12V DC power.
16. Check the LP gas safety shutoff.

REPLACING THE HEATER

The heat necessary for the operation of an absorption cooling unit is supplied by an electric heater mounted in a pocket of the boiler system. The refrigerator is equipped with a series connected twin heater.

To replace the heater, follow these steps:

1. Disconnect 120V AC and 12V DC power.
2. Remove the protection cover.
3. Remove the power module cover.
4. Disconnect the heater leads.
5. With a pair of pliers, unfold the lug holding the lid of the boiler casing and open the lid.
6. Remove some insulation wool so that the heater is accessible.
7. Turn and lift the heater out of its pocket.
8. Fit the new heater into the pocket.
9. Connect the leads.
10. Put back the power module cover.
11. Put back the insulation wool. Close the lid of the boiler.
12. Put back the protection cover.

REPLACING THE FUSES

POWER MODULE

To replace the fuses, follow these steps:

1. Disconnect 120V AC and 12V DC power.
2. Remove the power module cover.
3. Snap the fuse out of the fuse holder.
4. Fit a new fuse in to the fuse holder.
5. Put back the power module cover.

INLINE FUSE

The 3 A inline fuse for the power vent fans is connected to the 12V DC socket. To replace the inline fuse, follow these steps:

1. Disconnect 12V DC power.
2. Open the fuse holder.



3. Replace the fuse.



4. Put the holder back together.



TROUBLESHOOTING

TROUBLESHOOTING TABLE

If you run into a problem, refer to the troubleshooting table below.

Symptom	Check/Remedial action
The refrigerator has stopped cooling.	<ul style="list-style-type: none"> • Immediately turn the refrigerator off and see a Dometic dealer.
The refrigerator does not work on 120V AC	<ul style="list-style-type: none"> • Defective fuse? Fit a new fuse. • Connection to supply voltage? Establish power connection.
Refrigerator or freezer is not cold enough	<ul style="list-style-type: none"> • Is the plug firmly connected to the socket? Is the socket switched on? Check the socket by plugging in another appliance. • Is the thermostat properly set? • Is the refrigerator level? Because of its operation it is important to keep an absorption refrigerator level. • Heavy frost build-up on evaporator fins? To prevent frost buildup, which can reduce efficiency, do not leave the unit's door open longer than necessary. • Has the overheating protection been triggered or not? (Must be checked by an authorized service technician.) • Is there a power failure? Are the fuses intact for the AC supply and control system? • Has the door been closed properly? If not it can cause the inside temperature to rise. • Overpacked refrigerator? The unit will have to work harder if the refrigerator is stuffed and results in higher cabinet temperatures. Arrange the food in the unit to allow for free air circulation. • Venting problem? Restriction in air flow across cooling unit? Ensure that there is sufficient clearance between the refrigerator and the surrounding walls to allow for proper air circulation around the unit.
	NDA1402
	<ul style="list-style-type: none"> • Is the burner dirty, damaged or not properly located under the flue tube? • Is the burner jet clogged? • Is the flue baffle inserted properly in the flue tube? • Is the LP gas pressure low at burner? Set the main regulator to regulate the pressure so it does not drop below 11 inches water column at pressure tap.
The refrigerator does not work in gas operation mode	<ul style="list-style-type: none"> • Gas bottle empty? Change the gas bottle • Air in the gas pipe? Remove the air by switching the refrigerator on and off 3-4 times.
Odors from fumes	<ul style="list-style-type: none"> • Dislocated burner • Damaged burner • Dirty flue tube

If the problem persists and the refrigerator is still not working properly, contact your nearest Service Center. State the problem, model, product- and serial-number. (These details are stated on the data label inside the compartment.)

TROUBLESHOOTING

STATUS MESSAGES

Led display panel	Status message	Steady display	Flashing (Alt. between temp. and message)
"dE Fr"	Defrosting is just now performed	X	
"x " x is a figure 1-5	Thermostat range setting indication	X	
"ch LP"	Gas operation problem (NDA1402) ¹		X
"Lo dc"	DC voltage too low to start defrosting ²		X
"-- --"	Defrost timer not set (defrost timer needs to be set) ³		X
"Er 01"	Defrosting problem i.e. two uncompleted defrost sequences after each other ⁴		X
"Er 02"	Fan in frozen food compartment is blocked ⁵		X
"hl" in actual temp. field	Temperature is above measurement range ⁶	X	
"CA LL" and an error code	Severe faults ⁷		X

¹ Check to make sure that the LP-gas supply tanks are not empty and all manual shut off valves in the lines are open. If the refrigerator has not been in used for a long time or if the LP tanks just have been refilled, air may be trapped in the supply lines. To purge the air from the lines may require resetting the ON/OFF key several times.

² The DC voltage has for 3 hour period been too low to start a defrost sequence. Check battery charge level regular to overcome low DC voltage situations. Check the setting of the defrost timer, if necessary adjust to local or Central American time.

³ Refer to section SETTINGS.

⁴ Defrosting has been insufficient twice in a row (48 h) either because of the DC voltage being too low or no cooling source available or because of too much frost builds up. Check battery charge level regular to overcome low DC voltage situations. Check for proper wire size. For further information, refer to INSTALLATION > 12V DC CONNECTION. Use the manual defrost function to overcome excess of frost build up.

⁵ The fan has been blocked and is not circulating the air in the freezer compartment. Check the fan by unscrewing the bottom part of the fan housing. Try to rotate and look for ice build or other parts that can interfere with the rotation of the fan.

⁶ The compartment temperatures are warmer than 41°F in freezer and 59°F in fresh food compartment.

⁷ Refer to section CALL FOR SERVICE.

TROUBLESHOOTING

CALL FOR SERVICE

NEA1402



NDA1402



If the message “CA LL” is displayed on the LED panel a technical fault that need attention by Dometic personal has occurred. Call a Dometic service center for assistance as soon as possible and notify displayed error code to the service agent. Toll free number (800) 544-4881.

Error	Message displayed
Heating element in frozen food compartment faulty	”Er 11”
Heating element in fresh food compartment faulty	”Er 12”
Heating element in drain pipes faulty	”Er 13”
Fan in frozen food compartment faulty	”Er 14”
Fan in fresh food compartment faulty	”Er 15”
Air temperature sensor in frozen food compartment faulty	”Er 16”
Air temperature sensor in fresh food compartment faulty	”Er 17”
Temperature sensor on cooling surfaces in frozen food compartment faulty	”Er 18”
Temperature sensor on cooling surfaces in fresh food compartment faulty	”Er 19”

SERVICE MODE

NEA1402



NDA1402



Service mode is intended as a tool for service personnel only in order to perform diagnostic troubleshooting.

Before entering service mode:

1. Switch off the refrigerator with the ON/OFF key.
2. To enter service mode, press and hold SET key. Then, press the ON/OFF key.
3. Press the SET key to toggle the list of functions step by step.

No	Instruction	Note
00	—	—
01	LED panel check	All LED segments ON
02	Battery voltage check	”12” → in range between 8,5 - 18 V DC “Lo” or “hl” → out of range
03	Air temperature sensors, freezer + fridge	Value in °F → in range, “hl” or “Lo” → out of range, “-” → sensor fault
04	Surface temperature sensors, freezer + fridge	Value in °F → in range, “hl” or “Lo” → out of range, “-” → sensor fault
05	Door switches status	”OP” → open, “CL” → closed
06	Turn AC heater ON	”ON” → turned on, “no AC” → problem
07	Turn fridge heater ON	”ON” → turned on, “-” → problem
08	Turn freezer heater ON	”ON” → turned on, “-” → problem
09	Turn drain heater ON	”ON” → turned on, “-” → problem
10	Turn door heater ON	”ON” → turned on
11	Turn fridge fan ON	”ON” → turned on, “-” → problem
12	Turn freezer fan ON	”ON” → turned on, “-” → problem or “bL” → blocked
13	Turn gas ignition system ON (NDA 1402)	”FL” → turned on flame, “9” → sparking, “-” → problem

APPENDIX A - SPARE PARTS

Contact an authorized service center for parts and repairs as needed. For replacement parts suppliers, see the front page of this manual. Below you will find a list of commonly used parts which should be available from your Dometic Service Center.

Description	Part No.
Baffle (NDA1402)	293 26 67-05/4
Bottle holder, 5 pieces	293 26 58-01/2
Burner pipe, cpl. (NDA1402)	95 50 01-67/2
Crisper, 2 pieces	385 04 42-01/7
Door shelf, 2 pieces	293 25 77-03/0
Door shelf, 3 pieces (upper)	293 25 83-04/6
Door shelf, (lower)	385 04 45-01/0
Electrode with conductor (NDA1402)	293 27 81 02/0
Heater, 120V, 420W (2 x 60V, 210W)	385 06 44-53/9
Jet, no. 76 (NDA1402)	200 74 19-33/2
Lamp	200 72 90-00/6
Lamp cover	385 09 62-01/4

APPENDIX B - CONSUMER SUPPORT

Dometic website

www.dometicusa.com

Please visit the website for information and news about Dometic products. You can obtain information about how to get in contact, learn about product care, download manuals, leaflets and warranties.

Service and spare parts

For service, please contact the Service Center Assistance, see the front page of this manual - or - visit the Dometic website to find the location of the nearest Dometic Service Center.

Commonly used spare parts are listed in this manual, see APPENDIX A - SPARE PARTS. These should be available from your Dometic Service Center.

Contact us

For contact information, please see the frontpage of this manual - or - visit the Dometic website.

Register the appliance

www.edometric.com

Timely registration will allow for enhanced communication and service under the terms of the warranty, see APPENDIX C - DOMETIC WARRANTY & MAINTENANCE SCHEDULE.

To register the appliance, fill in the pre-printed registration card on the last page of this manual or register on-line at the Dometic website www.edometric.com.

To register on-line, follow these steps:

1. At www.edometric.com, click Warranty Registration.



2. Click Register your new Dometic product here.



3. Complete the information and then click the Submit Registration button.

A screenshot of the Dometic Owner's Registration form in Internet Explorer. The browser address bar shows 'http://www.edometric.com/allen/register/registration/openform'. The page title is 'Dometic Owner's Registration'. The form contains fields for 'First', 'Last', 'Street', 'City', 'State/Prov', 'Zip', 'Canadian Zip', 'Model Number', 'Serial Number', 'Date of Purchase', 'E-Mail Address', 'Home Phone', and 'Work Phone'. The 'Model Number' and 'Serial Number' fields are circled in red.

MANUFACTURED FOR THE DOMETIC CORP. ELAVANT TEL: 519-249-2511 (TOLL FREE) 1-800-368-2511 (CANADIAN DUTY-DIAZONA)		REFRIGERANT R134a		FOR MANUFACTURED HOME (MOBILE HOMES) OR RECREATIONAL VEHICLE INSTALLATION	
154624		EQUIPPED FOR LP GAS		FOR EACH INSTALLATION DASH WITH REFRIGERANT R134a	
120V 60Hz		12V		VEHICLE OF CAMPING	
12V		R134a		TESTED TO ISO 157/13 (15.66 MPa)	
INSTALL ONLY WITH VENT KIT ACCORDING TO FORM NO. 310 99 37...		INSTALLER UNDOUBTED AVEC LA TROUSSE D'AIR DE COMBUSTION		2932720-00 MADE IN SWEDEN	

The model number (e.g. RM3762) and serial number (e.g. 012 34567) are stated on the data label in the refrigerator compartment.

IMPORTANT!

Valuable Dometic Refrigerator Warranty & Maintenance Schedule

Congratulations, and Thank You for purchasing the industry's best built and best backed RV Refrigerator. Enclosed you will find important warranty and maintenance information on Dometic's exclusive three (3) year warranty. Please take a few moments and familiarize yourself with the program. We at Dometic appreciate your business and are confident that you will have many years of trouble-free RV enjoyment.

LIMITED THREE-YEAR WARRANTY DOMETIC REFRIGERATORS

THE SELLER NAMED BELOW MAKES THE FOLLOWING WARRANTY WITH RESPECT TO THE DOMETIC PRODUCT:

1. This warranty is made only to the first purchaser (herein after referred to as the "Original Purchaser") who acquires the product for his own use and is installed and operated within the continental United States and Canada.
2. This warranty will be in effect for three years on parts and freight and two years on labor from the date of purchase by the Original Purchaser. It is suggested that the original purchaser retain a copy of the dated bill of sale as evidence of the date of purchase.
3. This warranty covers only specified parts, which shall be free from defects in material and workmanship under normal use. This warranty does not cover conditions unrelated to the material and workmanship of the product. Such unrelated conditions include, but are not limited to: (a) damage not reported within the first 7 days of ownership; (b) faulty installation or installation that does not comply with RVIA standards, and any damage resulting from such; (c) the need for normal maintenance and any damage resulting from the failure to provide such maintenance; (d) failure to follow Sellers instructions for use of product; (e) any accident to or misuse of any part of this product and any alteration by anyone other than the Seller or its authorized representative; (f) any non-Dometic parts that are installed as replacement parts will void any warranty (implied or written); (g) blow out conditions; (h) radio frequency interference and electromagnetic interference; (i) 12V system chassis ground decay and corrosion; (j) puncture of foam cabinet or vacuum insulated panels after acknowledged receipt; (k) animal or insect infiltration which damages unit or inhibits performance; (l) abuse or misuse of electrical components.
4. The specified parts covered by this warranty are as follows: Major components (cooling unit, LP gas valve, burner, burner housing, electronic display, electronic module, evaporator fins, foam integrity, frame, thermister, spark probe, ignition wire, icemaker compressor, second absorption loop, display escutcheon, lower toe plate, humidity switch, frame heater mullion, icemaker mullion) are covered for parts and freight for three years and labor for two years from date of purchase. All other components that fail must be reported within the first 90 days of ownership in order to receive coverage of parts, freight and labor under warranty.
5. **This warranty requires the Original Purchaser to provide preventative maintenance on a yearly basis, starting at the anniversary of his date of purchase.** The Original Purchaser must keep a record of the preventative maintenance to keep the warranty in effect. Failure of the Original Purchaser in providing this annual maintenance may void the warranty. The preventative maintenance must be performed at a Dometic Authorized Service Center/Dealer. The preventative maintenance required is an inspection, cleaning and full diagnostics performed on the entire electronic system, burner assembly, wiring and cooling unit. A copy of the receipt covering the maintenance checks must accompany the warranty claim during the second and third year of ownership. The cost of this preventative maintenance is the Original Purchaser's responsibility and should take about one hour.
6. In order to obtain the benefits of this warranty, the original purchaser must return the product which is found defective to the Seller named below or to a Dometic Authorized Service Center during the period that this warranty is in effect. The original purchaser is responsible for all charges incurred in delivery of the product to the Seller or Dometic Authorized Service Center, and in pick up after the warranty service has been completed. To obtain the location of the nearest Authorized Service Center, please call 1-800-544-4881 or in Canada call 1-519-720-9578.
7. Any item returned in the manner described in paragraph 6 will be examined by the Seller or the Authorized Dometic Service Center. If it is found that the returned item was defective in material and workmanship, the Seller or the Authorized Dometic Service Center will repair the product per the terms outlined in paragraph 4. **CONFIRM THE SERVICE AGENCY IS AN AUTHORIZED DOMETIC SERVICE CENTER. DO NOT PAY THE SERVICE AGENCY FOR WARRANTY REPAIRS. SUCH PAYMENTS WILL NOT BE REIMBURSED.**
8. The Seller does not authorize any person or company to create any warranty obligations or liability on their behalf. This warranty is not extended by the length of time which you are deprived of the use of the product. Repairs and replacement parts provided under the terms of this warranty shall carry only the non-expired portion of this warranty.
9. In no event shall either seller be liable for incidental or consequential damages. This includes any damage to another product or products resulting from such a defect. Some states do not allow the exclusion or limitation of incidental or consequential damages, so the above limitations may not apply.
10. Any implied warranty, including the implied warranty of merchantability and fitness for any purpose, is limited to the duration of this limited warranty. Some states do not allow limitations on how long an implied warranty can last, so the above limitation may not apply.
11. **THIS WARRANTY GIVE SPECIFIC LEGAL RIGHTS, YOU MAY ALSO HAVE OTHER RIGHTS WHICH VARY FROM STATE TO STATE.** No action to enforce this warranty shall be commenced later than ninety (90) days after the expiration of the warranty period. Claims must be submitted in writing to the Dometic Warranty Department for arbitration.
12. All products (except those specifically built for commercial use) are warranted only when installed on vehicles built to R.V.I.A and C.R.V.A, Z-240 Standards.
13. The Seller reserves the right to change the design of any product without notice and with no obligation to make corresponding changes in products previously manufactured.

DOMETIC CORPORATION
Warranty Department
2320 Industrial Parkway
Elkhart, IN 46516
Phone: 574-294-2511
Fax: 574-293-9686

REFRIGERATOR OWNER MAINTENANCE YEARLY RECORD

Customer Name: _____ **Model No.:** _____ **Date of Purchase:** _____
Address: _____ **Serial No.:** _____
City: _____ **State:** _____ **Zip Code:** _____
Phone: _____

FIRST YEAR	SECOND YEAR																																										
Date: _____	Date: _____																																										
Dealership: _____	Dealership: _____																																										
Address: _____	Address: _____																																										
City: _____	City: _____																																										
State: _____ Zip: _____	State: _____ Zip: _____																																										
Phone: _____	Phone: _____																																										
Technician: _____	Technician: _____																																										
Cleaned Burner Assembly: Yes / No Cleaned/Check All Terminals Connections: Yes / No Cleaned/Inspect All Ground Connections: Yes / No Inspect and Test Door Seals: Yes / No Inspect and Tighten LP Lines: Yes / No Power Ventilator Installed: Yes / No *Gas Safety Shutdown in 45 seconds: Yes / No	Cleaned Burner Assembly: Yes / No Cleaned/Check All Terminals Connections: Yes / No Cleaned/Inspect All Ground Connections: Yes / No Inspect and Test Door Seals: Yes / No Inspect and Tighten LP Lines: Yes / No Power Ventilator Installed: Yes / No *Gas Safety Shutdown in 45 seconds: Yes / No																																										
<table style="width: 100%; border-collapse: collapse;"> <thead> <tr> <th style="width: 60%;"></th> <th style="width: 15%; text-align: center;">ACTUAL</th> <th style="width: 25%; text-align: center;">SPEC. RANGE</th> </tr> </thead> <tbody> <tr> <td>Electrode Gap</td> <td style="text-align: center;">_____</td> <td style="text-align: center;">3/16"</td> </tr> <tr> <td>Thermister Reading</td> <td style="text-align: center;">_____</td> <td style="text-align: center;">7-10,000 ohms @ 32°</td> </tr> <tr> <td>*D/C Voltage</td> <td style="text-align: center;">_____</td> <td style="text-align: center;">9.5 to 15 volts D/C</td> </tr> <tr> <td>*A/C Voltage</td> <td style="text-align: center;">_____</td> <td style="text-align: center;">120 Volts ± 10%</td> </tr> <tr> <td>Thermocouple Reading</td> <td style="text-align: center;">_____</td> <td style="text-align: center;">25-35 Millivolts</td> </tr> <tr> <td>*Delay Between Modes</td> <td style="text-align: center;">_____</td> <td style="text-align: center;">Approx. 5 seconds</td> </tr> </tbody> </table> * Use PAL RV Diagnostic Tool for these tests.		ACTUAL	SPEC. RANGE	Electrode Gap	_____	3/16"	Thermister Reading	_____	7-10,000 ohms @ 32°	*D/C Voltage	_____	9.5 to 15 volts D/C	*A/C Voltage	_____	120 Volts ± 10%	Thermocouple Reading	_____	25-35 Millivolts	*Delay Between Modes	_____	Approx. 5 seconds	<table style="width: 100%; border-collapse: collapse;"> <thead> <tr> <th style="width: 60%;"></th> <th style="width: 15%; text-align: center;">ACTUAL</th> <th style="width: 25%; text-align: center;">SPEC. RANGE</th> </tr> </thead> <tbody> <tr> <td>Electrode Gap</td> <td style="text-align: center;">_____</td> <td style="text-align: center;">3/16"</td> </tr> <tr> <td>Thermister Reading</td> <td style="text-align: center;">_____</td> <td style="text-align: center;">7-10,000 ohms @ 32°</td> </tr> <tr> <td>*D/C Voltage</td> <td style="text-align: center;">_____</td> <td style="text-align: center;">9.5 to 15 volts D/C</td> </tr> <tr> <td>*A/C Voltage</td> <td style="text-align: center;">_____</td> <td style="text-align: center;">120 Volts ± 10%</td> </tr> <tr> <td>Thermocouple Reading</td> <td style="text-align: center;">_____</td> <td style="text-align: center;">25-35 Millivolts</td> </tr> <tr> <td>*Delay Between Modes</td> <td style="text-align: center;">_____</td> <td style="text-align: center;">Approx. 5 seconds</td> </tr> </tbody> </table> * Use PAL RV Diagnostic Tool for these tests.		ACTUAL	SPEC. RANGE	Electrode Gap	_____	3/16"	Thermister Reading	_____	7-10,000 ohms @ 32°	*D/C Voltage	_____	9.5 to 15 volts D/C	*A/C Voltage	_____	120 Volts ± 10%	Thermocouple Reading	_____	25-35 Millivolts	*Delay Between Modes	_____	Approx. 5 seconds
	ACTUAL	SPEC. RANGE																																									
Electrode Gap	_____	3/16"																																									
Thermister Reading	_____	7-10,000 ohms @ 32°																																									
*D/C Voltage	_____	9.5 to 15 volts D/C																																									
*A/C Voltage	_____	120 Volts ± 10%																																									
Thermocouple Reading	_____	25-35 Millivolts																																									
*Delay Between Modes	_____	Approx. 5 seconds																																									
	ACTUAL	SPEC. RANGE																																									
Electrode Gap	_____	3/16"																																									
Thermister Reading	_____	7-10,000 ohms @ 32°																																									
*D/C Voltage	_____	9.5 to 15 volts D/C																																									
*A/C Voltage	_____	120 Volts ± 10%																																									
Thermocouple Reading	_____	25-35 Millivolts																																									
*Delay Between Modes	_____	Approx. 5 seconds																																									
<p style="text-align: center;">ICEMAKER MODELS</p> Inspect Water Valve and All Connections: Yes / No Inspect Heat Tape Switch for Proper Operation: Yes / No	<p style="text-align: center;">ICEMAKER MODELS</p> Inspect Water Valve and All Connections: Yes / No Inspect Heat Tape Switch for Proper Operation: Yes / No																																										

PROTECTION FOR YOUR NEW INVESTMENT

We truly appreciate that you have chosen to purchase a Dometic product for your recreational vehicle and we want to help you protect this wise investment.

We at Dometic back our products with one of the most comprehensive warranties in the industry. Complete the registration card below and mail to us or register your Product on-line at www.edometic.com.



TIME-DATED MATERIAL
Please Process Promptly!

Tape here

FIRST CLASS POSTAGE REQUIRED

 **Dometic**[®]

Dometic Processing Center
2320 Industrial Parkway
Elkhart, IN 46516

Tape here

■ **WARRANTY VERIFICATION**

Your prompt registration records your right to protection under the terms and conditions of your warranty.

■ **FACTORY COMMUNICATION**

Returning your card of registering on-line guarantees you will receive product information and specials. Leaving your email address below will allow us to communicate with you quickly and efficiently.

■ **OWNER CONFIRMATION**

Your completed Owner's registration card serves as confirmation of ownership in the event of product damage or theft.

■ **3 PLUS 3 SERVICE CONTRACT**

Returning the card below or registering on-line assures you of an invitation to take advantage of an Optional 3 Plus 3 Full Service Contract which allows you to add up to 3 years of additional warranty coverage.



Return the card within **10** days to ensure your:

- WARRANTY VERIFICATION
- FACTORY COMMUNICATION
- OWNER CONFIRMATION
- 3 PLUS 3 SERVICE CONTRACT

Fold here. Close with tape.

TO THE INSTALLER
 PLEASE AFFIX THESE INSTRUCTIONS
 TO THE REFRIGERATOR
 —
TO THE CONSUMER
 PLEASE RETAIN THESE INSTRUCTIONS
 FOR FUTURE REFERENCE

IMPORTANT:
Return Within
10 days



Owner's Registration Card

Registering your product is an essential step to ensure that you receive all the benefits you are entitled to as a DOMETIC customer. Complete the information below and mail to us or register on-line at www.edometic.com.

Be sure to include your email address so that we can communicate with you quickly and efficiently. Your address will remain confidential and will not be distribute to third parties.

Name

Address

City Stat/Prov.

Date of Purchase Zip/Postal Code

MO DAY YEAR

Email Address

REFRIGERATOR MODEL NUMBER

SERIAL NUMBER