

# WIRING DIAGRAM

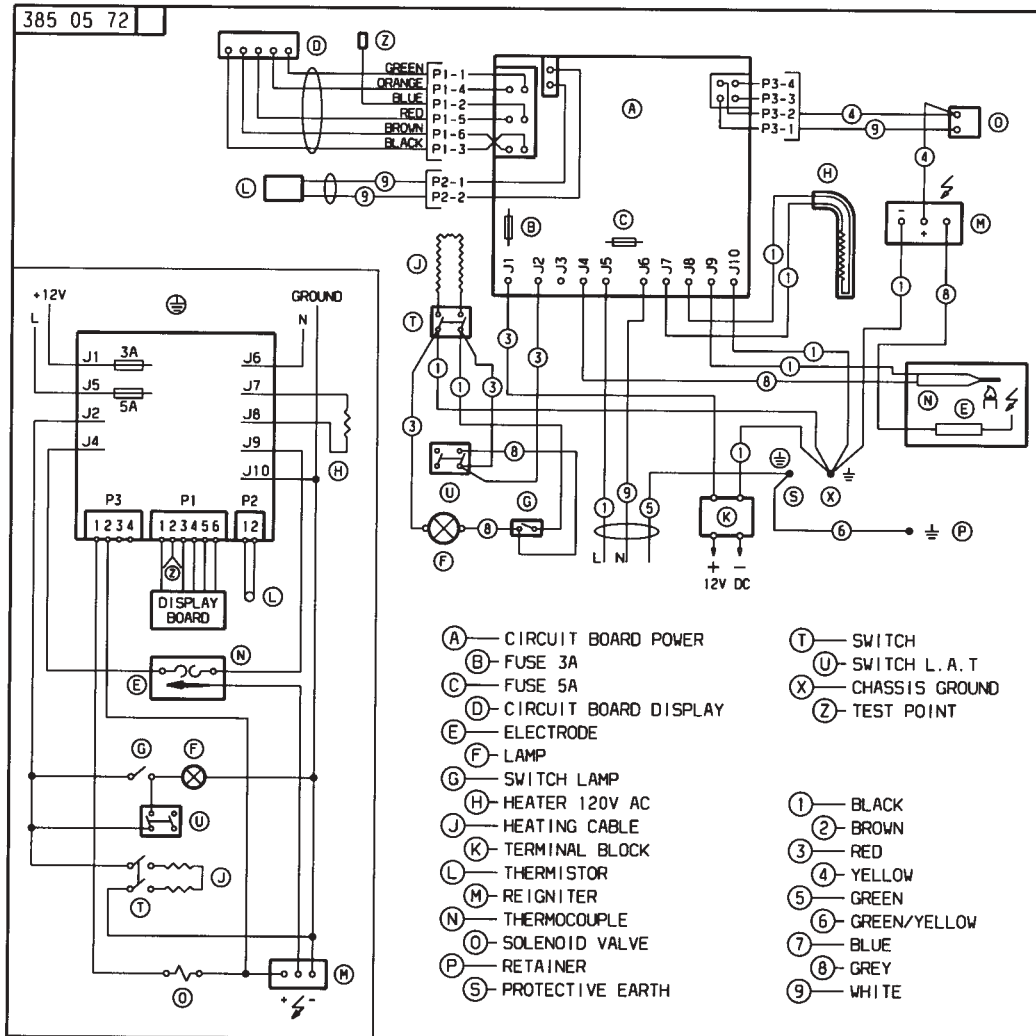

N38505720