

WIRING DIAGRAM

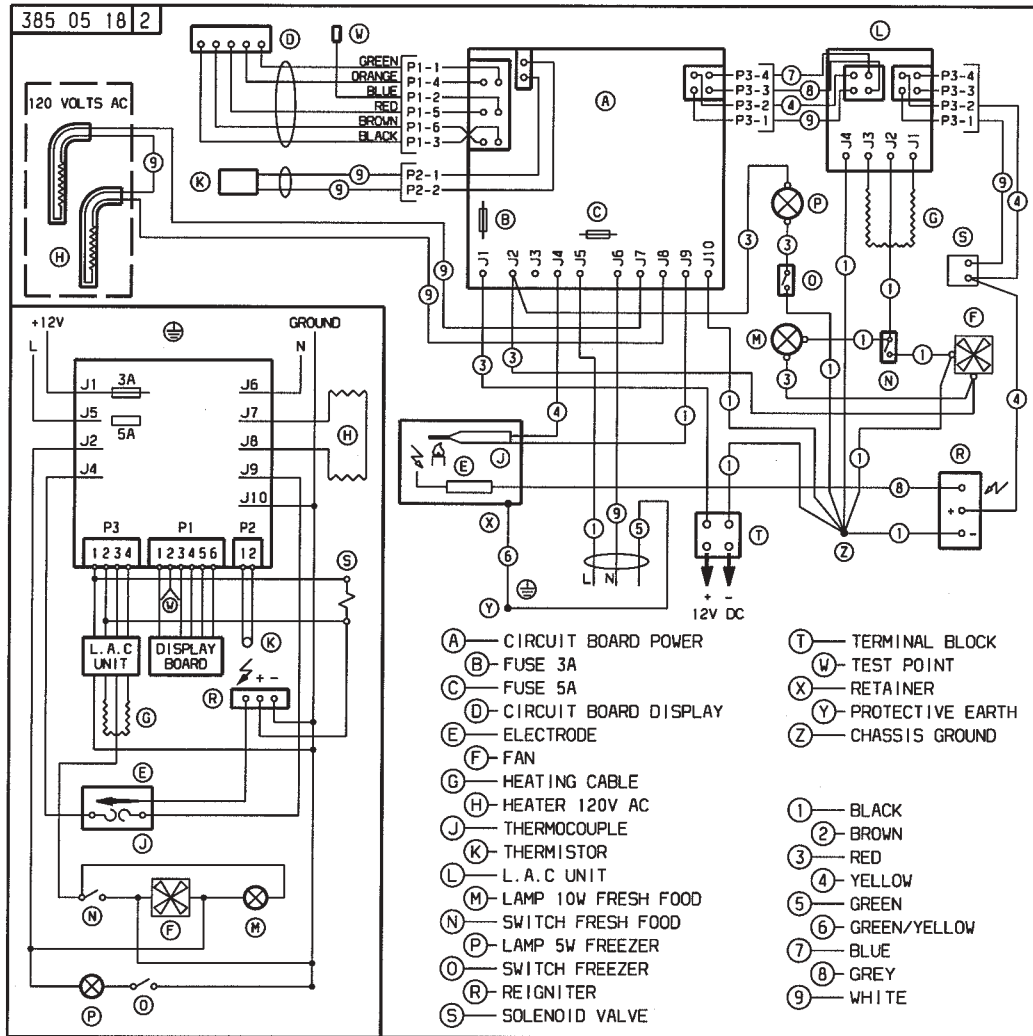

N38505182