

# WIRING DIAGRAM

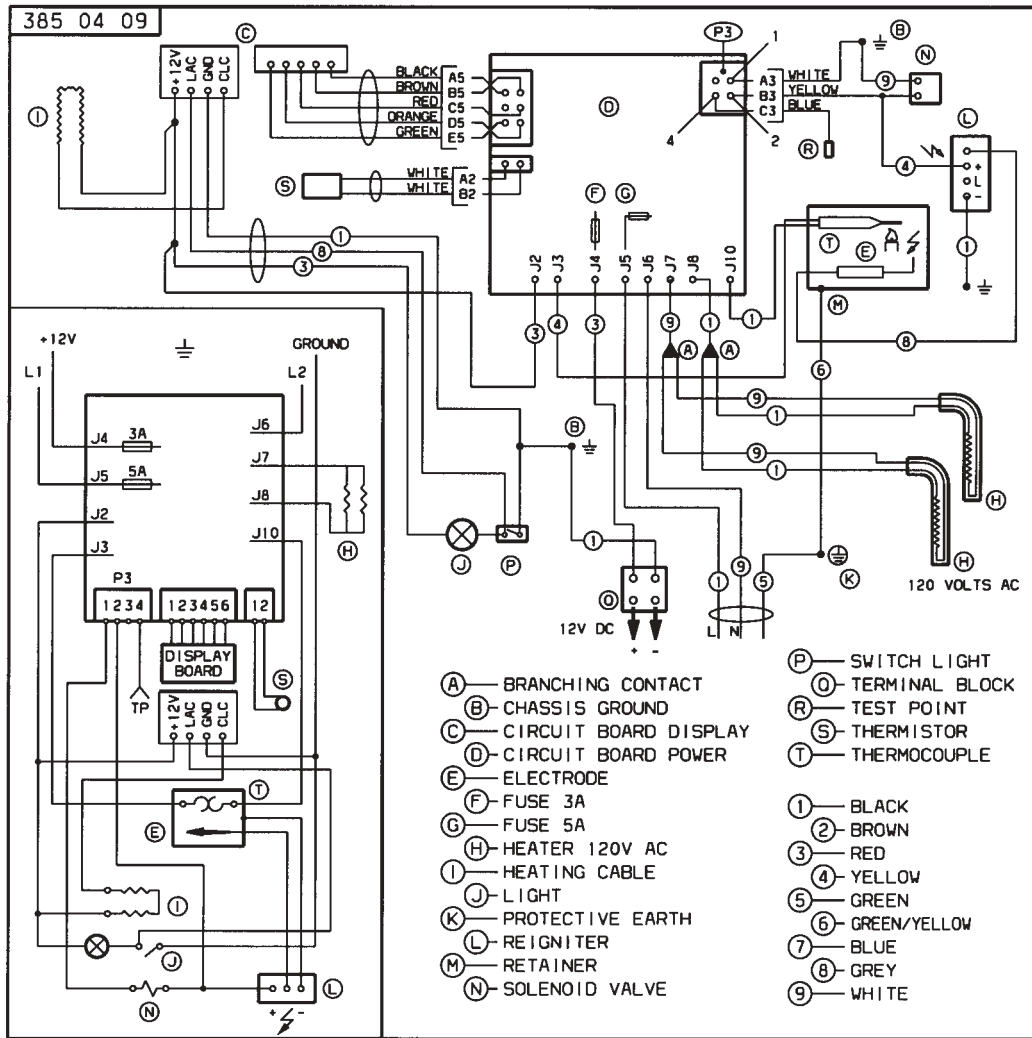

N38504090