

DINOSAUR ELECTRONICS

1160 SE 27th St.
Lincoln City, OR 97367
(541) 994-4344

Micro P-246 Instructions

The Micro P-246 Plus board is a replacement control Board for Dometic refrigerators. It has been designed to replace Dinosaur Electronic's Micro P-24 2-way, Micro P-24 3-way, Micro P-26 and all of the Dometic model boards that they will replace. The board comes configured to work in 3-way refrigerators and a jumper can be cut to make it work in 2-way refrigerators.

The board comes configured to work with the old style gas valve shown on the right. A jumper can be cut to make it work with the new style gas valve that comes with Dometic's kit shown below.

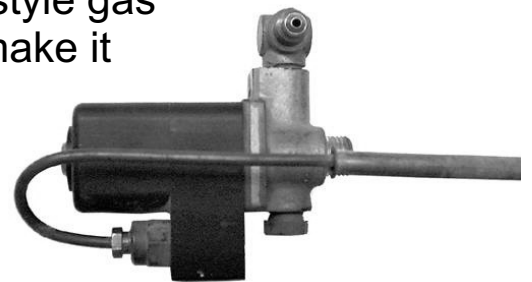

Old Style Gas Valve (Webber)

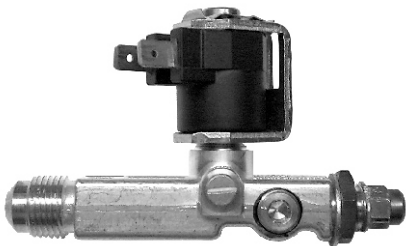

New Style Gas Valve

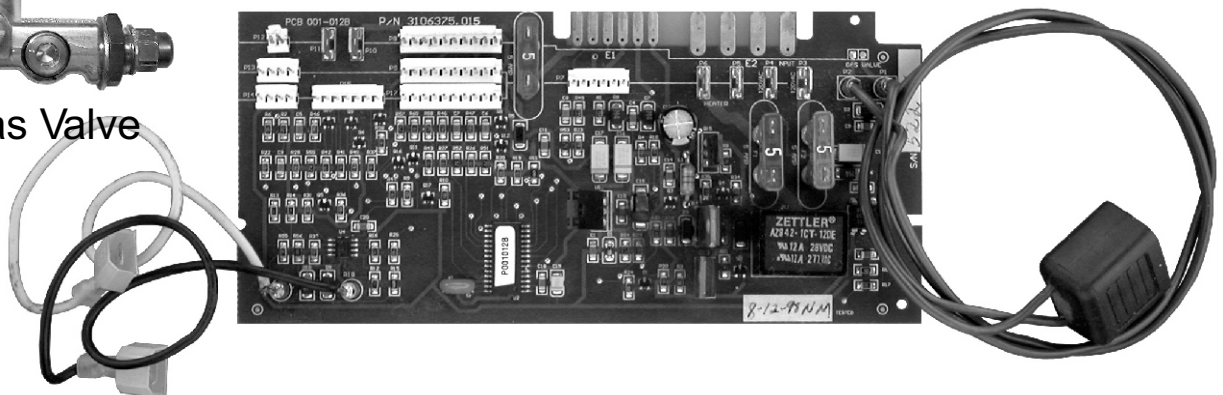

If you have one of the following Dometic refrigerator models: RM663, RM763, RM773, RM1303, RM3500, RM3600, RM3800 That uses Dometic's kits with the new style gas valve, use Dinosaur Electronics Micro P-1338 Rev. 5 board.

If you have one of the following Dometic refrigerator models: RM2602, RM2603, RM2802, RM2803, RM3501, RM3601, RM3604, RM3801, RM3804, RM4801, RM4804, RM4808.002, RM4804.004, RM4804.005, RM4804.006, RM7030 Prod. #921890201 or RM7030 Prod. # 921890301 that uses Dometic's kits with the new style gas valve Then use Dinosaur Electronics Micro P-246 Plus board.

Pinouts for the MICRO P-246 Plus Board

Important!: The actual color of the wires may be different!

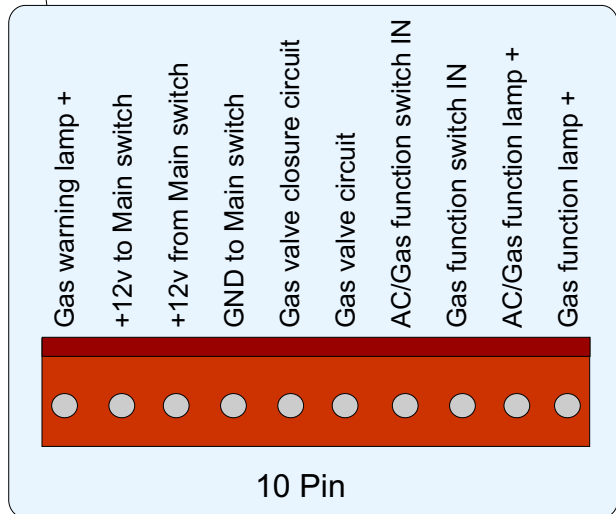
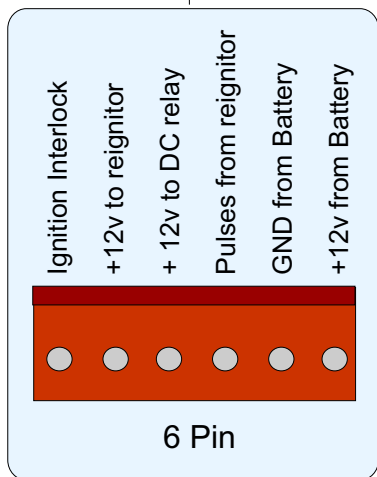
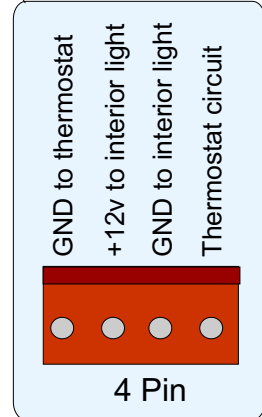
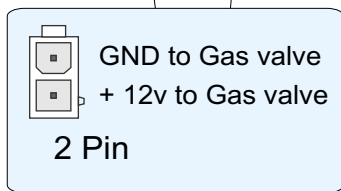
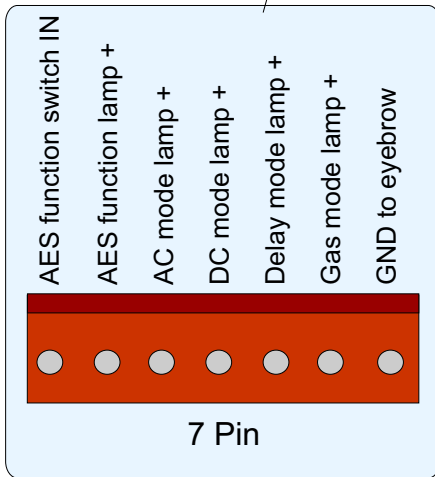
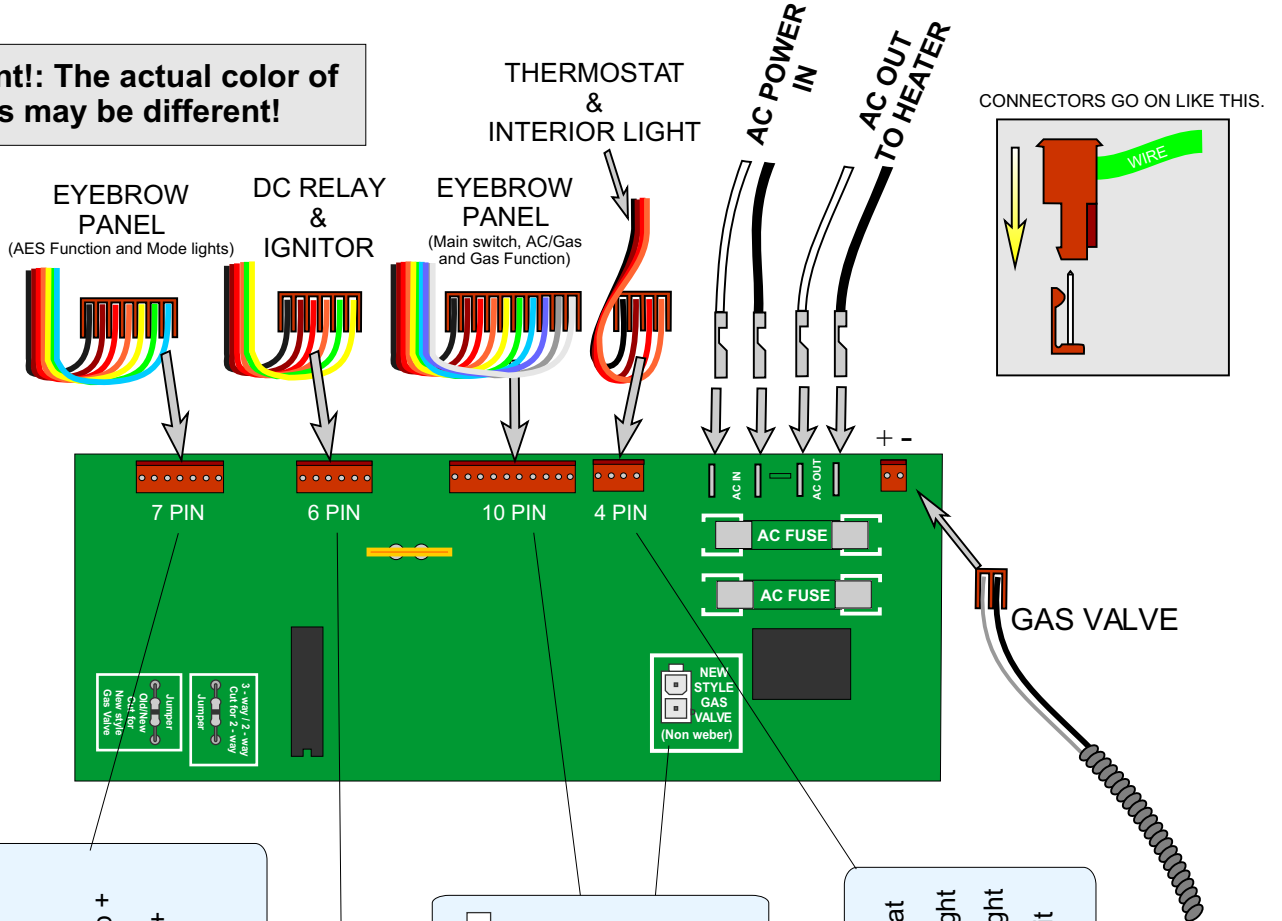

Installing the MICRO P-246 Plus Board

Important!: The actual color of the wires may be different!

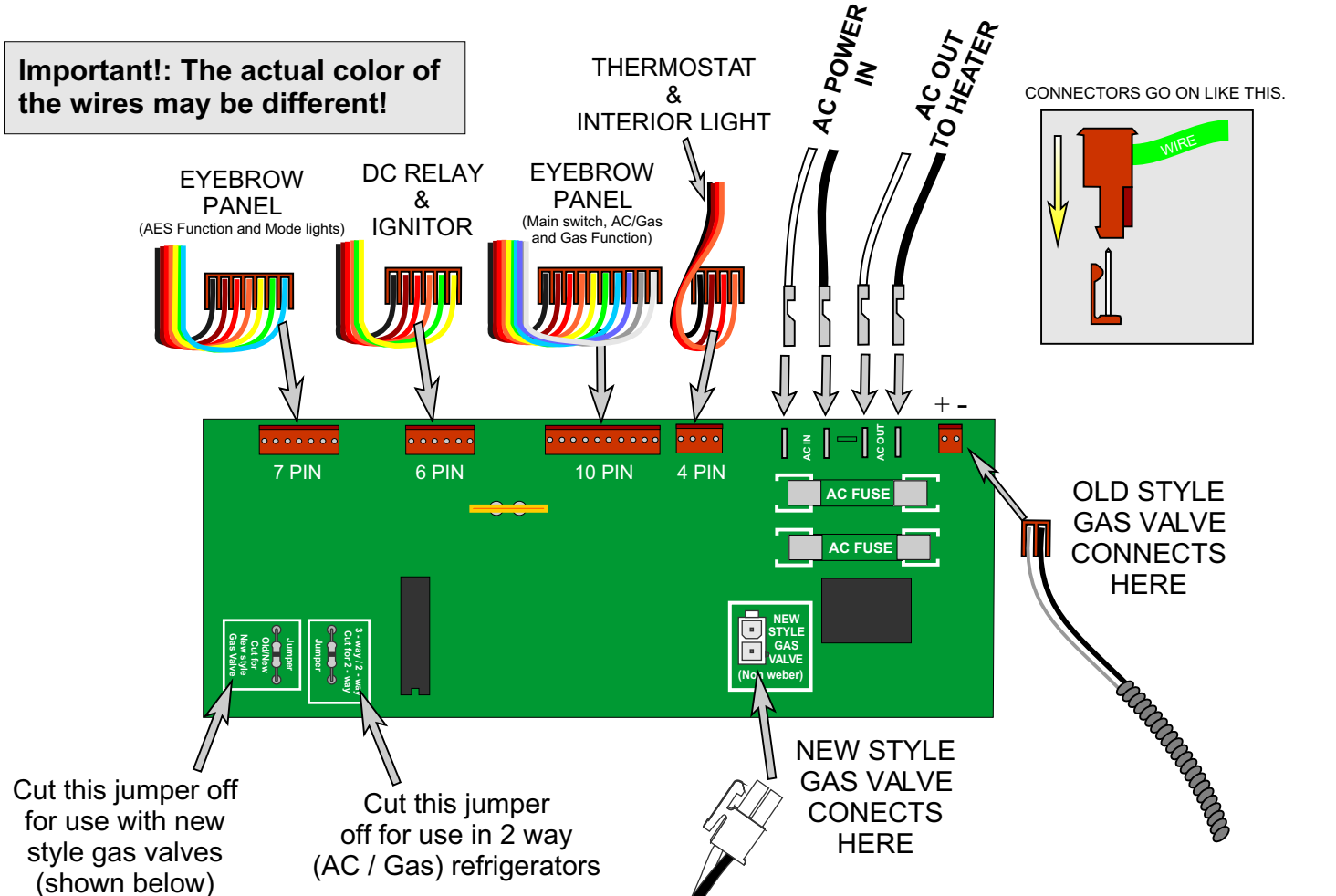

Cut this jumper off for use with new style gas valves (shown below)

Cut this jumper off for use in 2 way (AC / Gas) refrigerators

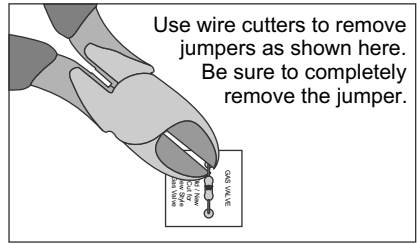

Use wire cutters to remove jumpers as shown here. Be sure to completely remove the jumper.

- 1) If the refrigerator is a 3 way, leave the 2 way jumper alone. If it is a 2 way, completely remove the 2 way jumper.
- 2) Determine which gas valve type you are using (see gas valve types at the bottom of this page). If you are using the old style gas valve do not cut the jumper. If you are using the new style gas valve completely remove the jumper.
- 3) When reconnecting the wires to the board, 2 way refrigerators may not have the 7 pin connector.

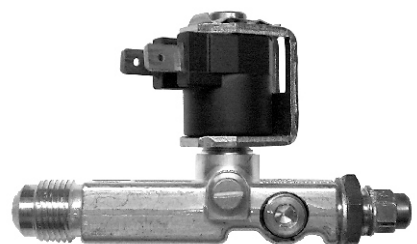
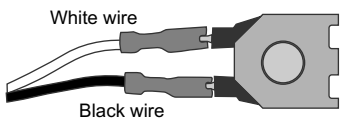

New Style Gas Valve

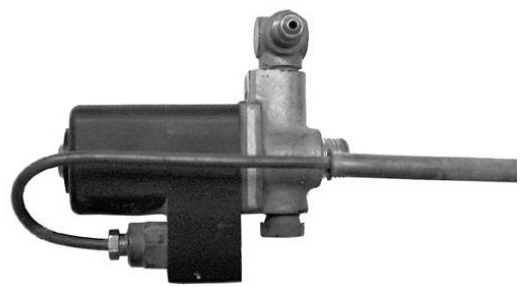

Old Style Gas Valve (Webber)