

NORCOLD Refrigerator Service Manual



Models:

DC0040(K), DC0051(K)

DE0040, DE0051

DE0240T, DE0251T

Norcold, Inc.
P.O. Box 4248
Sidney, OH 45365-4248

Troubleshooting – Table of Contents

➤ Procedure A – Thermostat “ON” compressor does not run...	3
➤ Procedure B – Compressor resistance.....	4
➤ Procedure C – Power supply output voltage.....	5
➤ Procedure D – Compressor amp draw.....	6
➤ Procedure E – Evaporator thermistor resistance.....	7
➤ Procedure F – Insufficient cooling.....	8
➤ Procedure G – Refrigerator too cold.....	8
➤ Procedure H – Auto shut-off device.....	8
➤ Procedure I – Ventilation.....	9
➤ Wiring schematic.....	9
➤ Quick reference repair sheet.....	10



Warning

Perform all tests using a fully charged 12V DC battery. Using other equipment that supplies DC voltage may cause permanent refrigerator component failure.

Troubleshooting – Procedure A

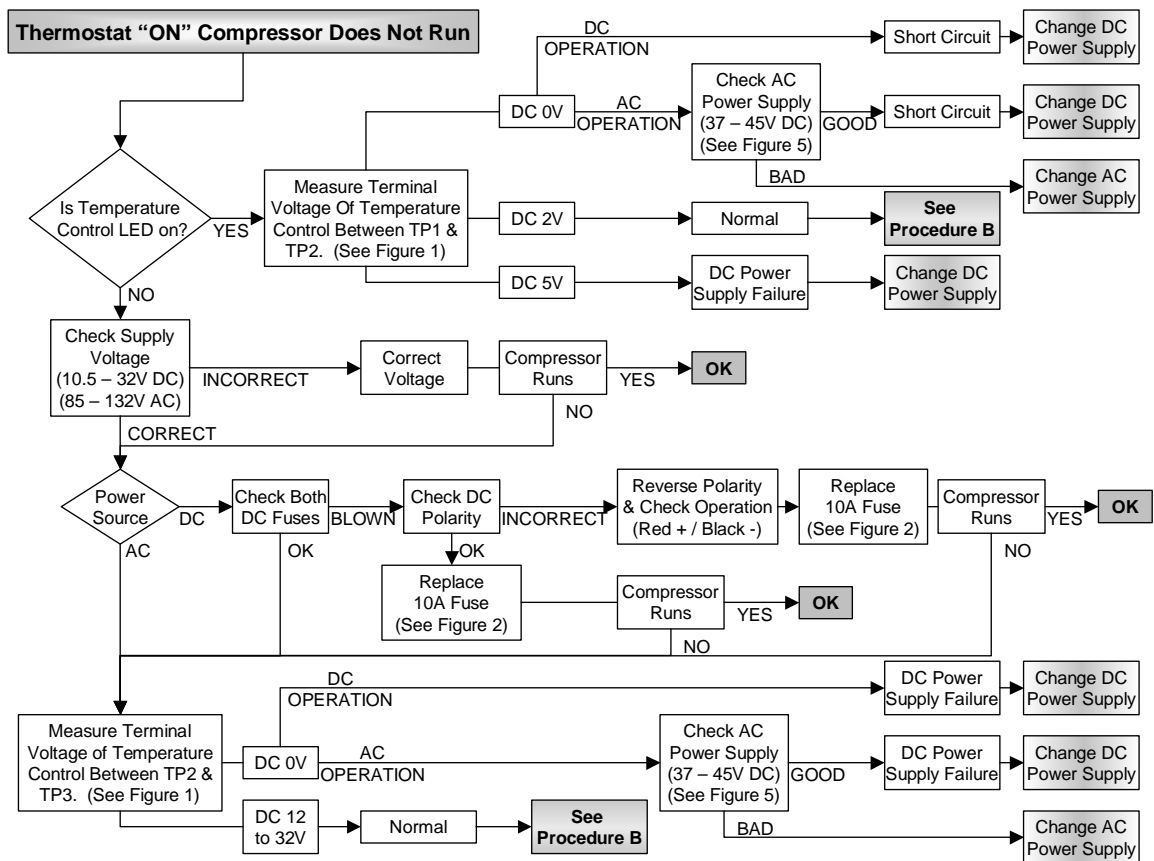

Note: Measurements taken with 12.8V DC or 120V AC power supply.

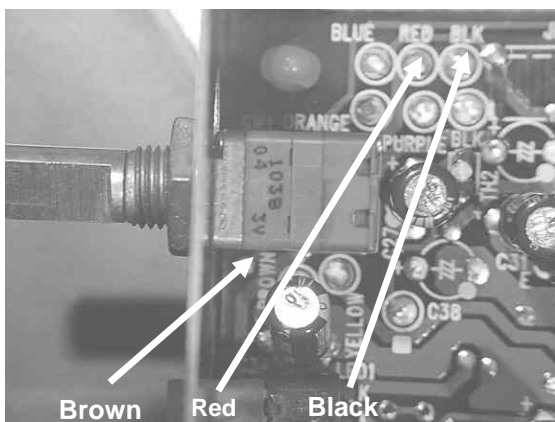

Figure 1 – Temperature Control

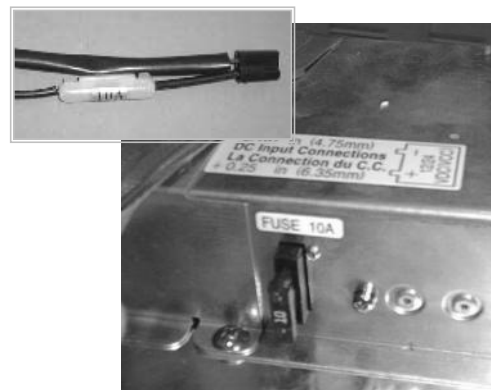
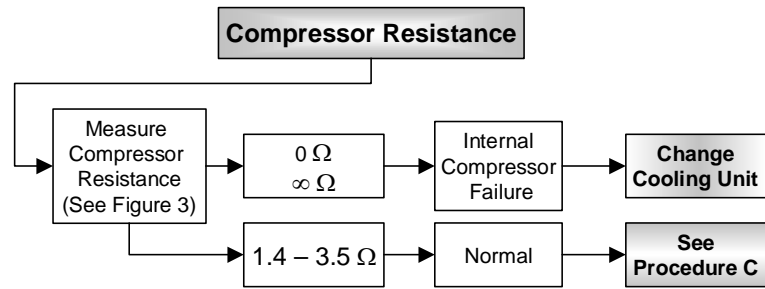

Figure 2 – Fuse Locations
Note: If 10 Amp fuse is blown, check wiring of vehicle.

Troubleshooting – Procedure B



Note: Perform procedure at room temperature.

Turn the refrigerator to OFF.

Remove the black wire to the compressor. Measure the resistance of the compressor between point A and point B.

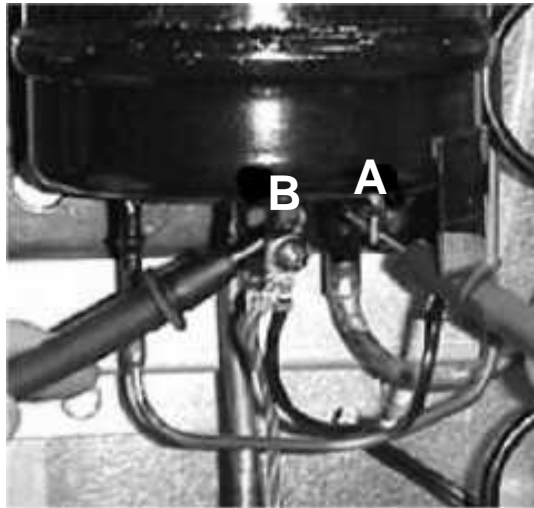
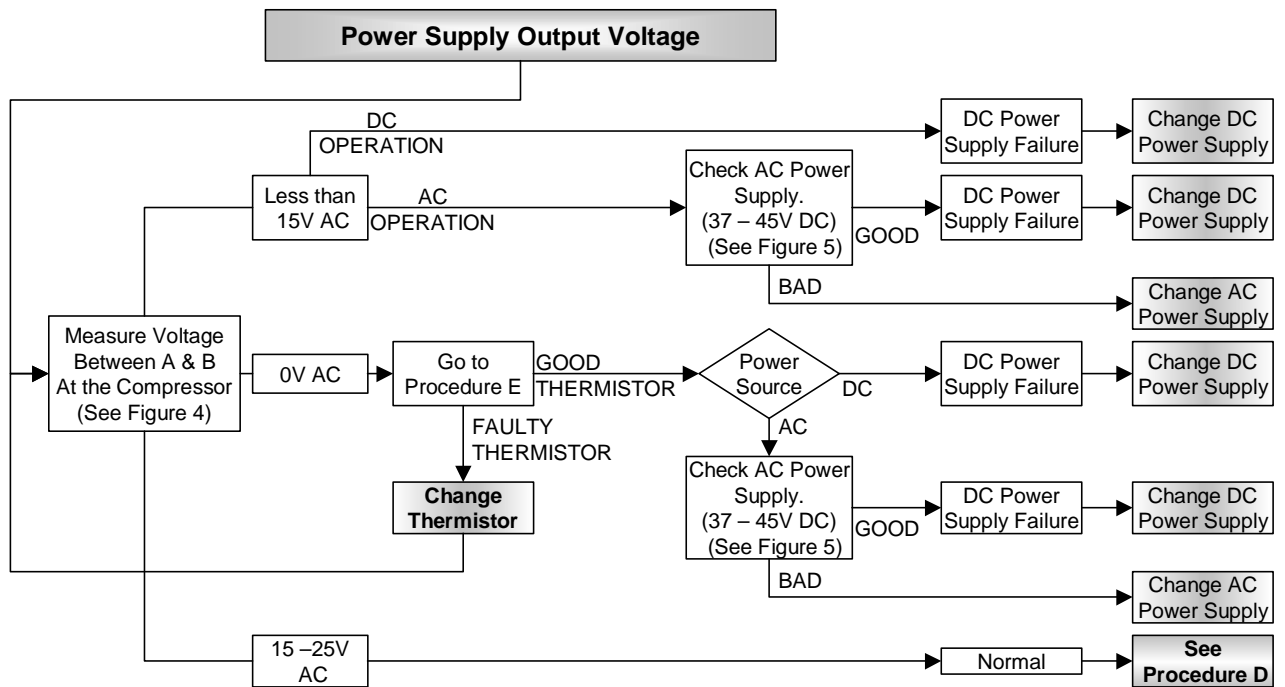

Figure 3 – Measuring Compressor Resistance

Troubleshooting – Procedure C



Note: Measurements taken with 12.8V DC or 120V AC power supply.

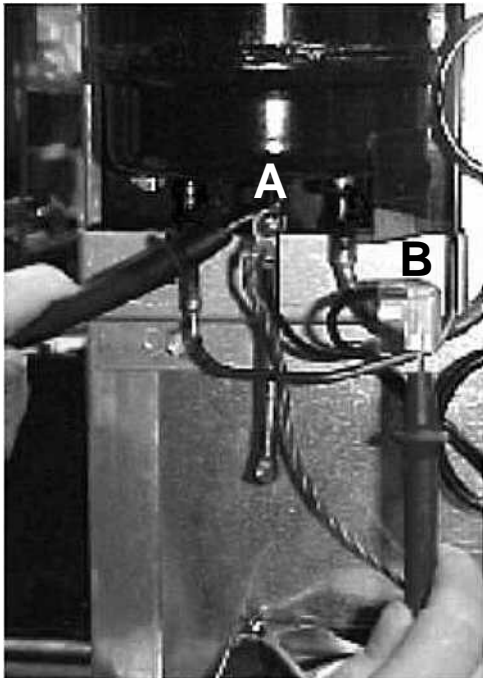
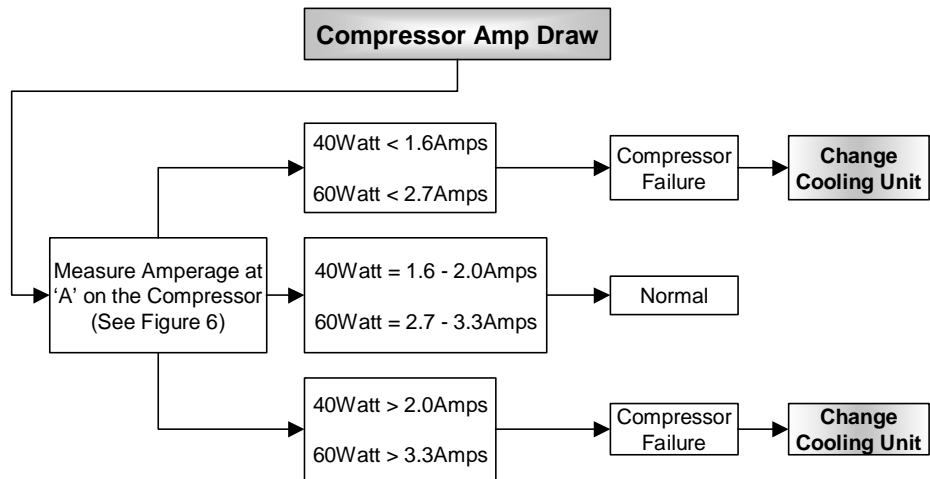

Figure 4 – Measuring Power Supply Output Voltage



Figure 5 – Measuring AC Power Supply Output

Troubleshooting – Procedure D



Note: Measurements taken with 12.8V DC power supply.

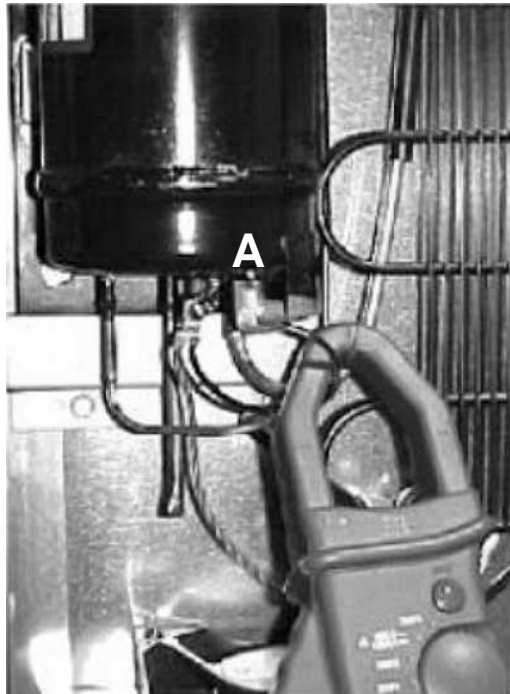

Figure 6 – Measuring Amp Draw of Compressor

Thermistor Operation Verification

To measure the resistance of the evaporator thermistor, turn the refrigerator to the OFF position.

Disconnect the three-pole connector (Figure 7), and measure resistance across the two pins. (Figure 8)

Check the evaporator thermistor by measuring the temperature and resistance of the thermistor. Refer to

Table 1 for a listing of acceptable resistance ranges.

In general:

1.6K – 29KΩ = good thermistor.

∞Ω = defective thermistor. An open thermistor will stop normal compressor operation. Replace the defective thermistor.

Evaporator Thermistor Resistance			
Thermistor Temperature		Resistance	Allowable Resistance Range
(°F)	(°C)		
0	-18	9.7 KΩ	8.7 - 10.7 KΩ
10	-12	7.8 KΩ	7.0 – 8.6 KΩ
20	-7	6.4 KΩ	5.7 – 7.0 KΩ
30	-1	5.3 KΩ	4.8 – 5.7 KΩ
40	4	4.5 KΩ	4.0 – 4.9 KΩ
50	10	3.6 KΩ	3.2 – 4.0 KΩ
60	16	2.8 KΩ	2.5 – 3.1 KΩ
70	21	2.1 KΩ	1.9 – 2.3 KΩ
80	27	1.9 KΩ	1.7 – 2.0 KΩ
90	32	1.8 KΩ	1.6 – 1.9 KΩ

(Table 1)



Figure 7 – Evaporator Thermistor Connection (inside power supply)



Figure 8 – Measure Resistance Across Pins

Troubleshooting – Procedure F

Insufficient Cooling

Note: Check input voltage before proceeding. Refer to **Procedure A**.

If compressor runs continuously:

- Check the voltage across the fan leads. There will be a slight voltage reading even if the fan isn't operational. The fan will only operate when the compressor is running, and the ambient temperature is sufficient to engage the fan. The operational voltage of the fan is between 17 and 22VDC. If this is present at the leads and the fan is not running, replace the fan. (Note: When servicing fan,

do not short the wires; this will damage the power supply.

- Make sure the ventilation vents are not blocked. Refer to **Procedure I**.
- Make sure the auto shut-off device is operational. Refer to **Procedure H**.
- If the reason for insufficient cooling is not found, start with **Procedure B**.

Replace cooling unit if:

- Compressor is hot to the touch and not vibrating.
- Compressor vibrates and no cooling

Troubleshooting – Procedure G

Refrigerator too Cold

- Adjust temperature control to lower setting. (#1 = Warm, #5 = Coldest.)
- Make sure thermistor is securely mounted to the evaporator plate.
- If the reason is not found, refer to **Procedure E**.

Troubleshooting – Procedure H

Auto Shut-off Device

Note: Only the 12/24V DC models are equipped with the auto shut-off device within the power supply.

Shut-off Device Operation

To protect the cooling unit from overheating, the refrigerator will automatically shut-off when the ambient air temperature is approximately 110°F. If shut-off occurs, the refrigerator will sound an intermittent alarm tone. To stop the alarm, the refrigerator must be restarted. This can be done by turning the thermostat knob counterclockwise to the OFF position and then turning it back to the desired setting. The refrigerator will not restart until the ambient conditions allow for normal operation. The

functionality of the shut-off device can be tested by heating it with a heat gun (See Figure 9).

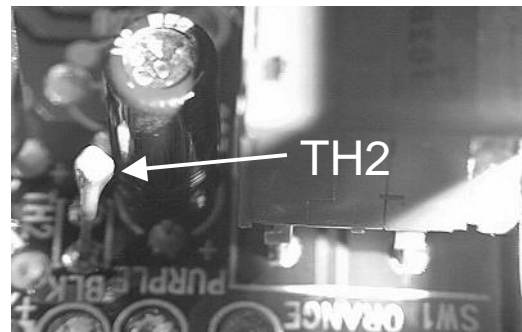

Figure 9 – High Temperature Shut-off Device

Ventilation – Procedure I

Ventilation is necessary for the correct operation of the refrigerator. Good ventilation also increases the life of the refrigerator cooling system. The current models are equipped with built-in ventilation systems that draw cooler air through the lower intake vent. This air is then circulated over the cooling unit to remove excess heat from the cooling system. The heated air is then rejected through the upper vent. If this airflow is blocked or decreased, the refrigerator

will not cool correctly. Do not block the vents by closet or cabinet doors. Vent blockage that reduces the vent area can cause:

- Shortened life of the refrigeration-cooling unit.
- Poor cooling performance of the refrigerator.
- Continuous operation of the refrigerator.
- Fast battery discharge.
- Void the refrigerator warranty.

Troubleshooting – Wiring Schematic

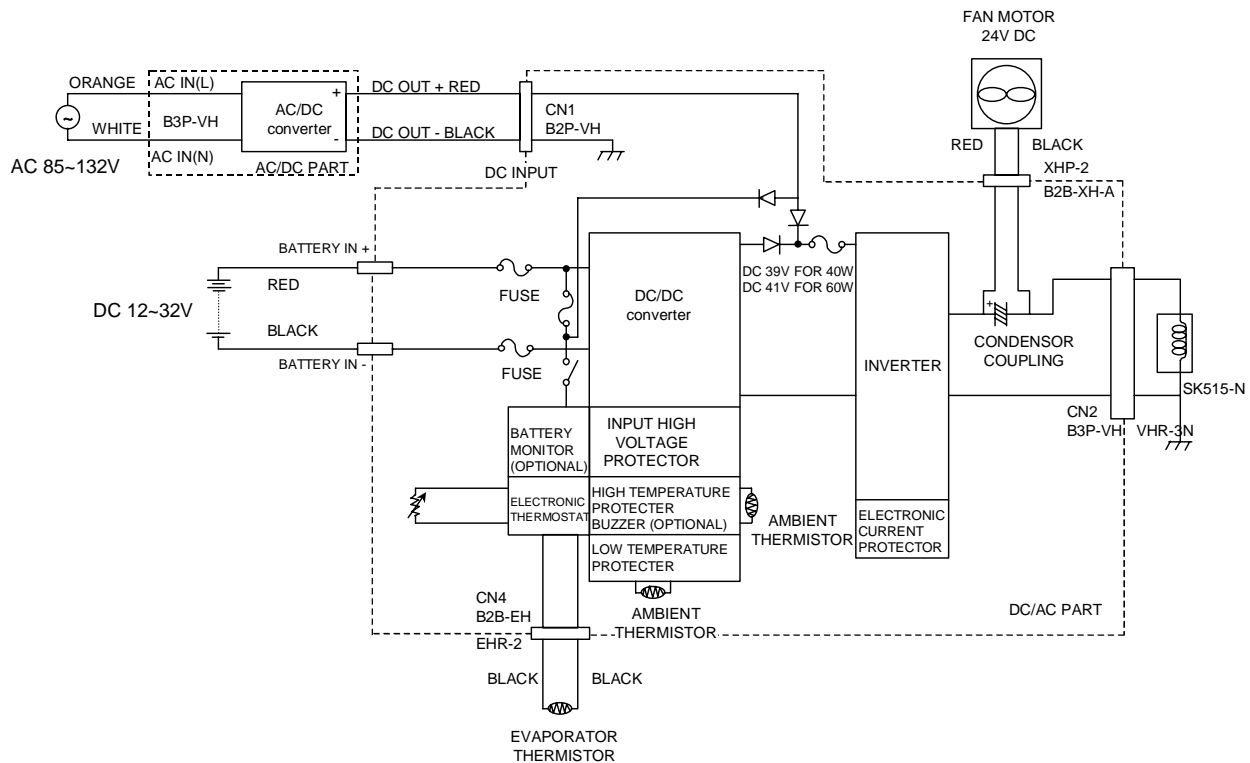

Troubleshooting – Quick Reference

1. Check for supply voltage at rear of the refrigerator. Turn refrigerator ON. The operating voltage should be between 10.5V and 32V DC. There will be some variation in these readings depending on the supply voltage.
2. Check for voltage (15V – 25V AC) at compressor between points A and B (See Figure 10). If voltage is not within range, refer to **Procedure C** on page 5.

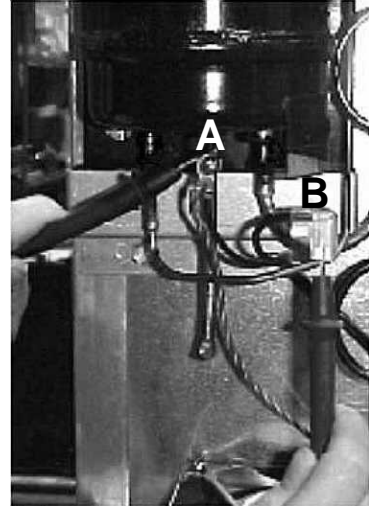

Figure 10

3. Take an Ohm reading (1.4 – 3.5 Ω) at compressor between points A and B (See Figure 11). If Ohm reading is not within range, refer to **Procedure B** on page 4.

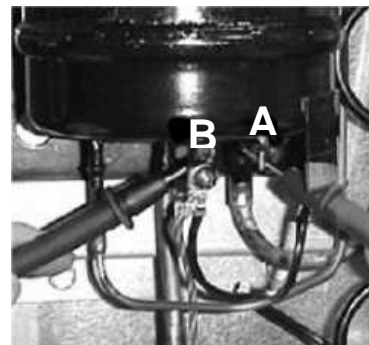

Figure 11

4. Take an Amp reading (1.6 – 3.3 Amps) at the black wire with the rubber boot (See Figure 12). If amperage is not within range, refer to **Procedure D** on page 6.

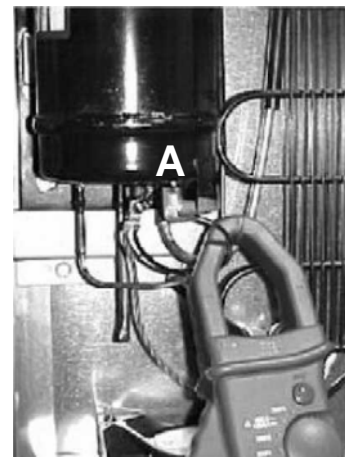

Figure 12

