



## Owner's and Installation Manual

- For models DC8511 - 12/24 Volts DC refrigerators
- For models DC8512 - 12/24 Volts DC refrigerators
- For models DC7341 - 12/24 Volts DC refrigerators
- For models DC3984 - 12/24 Volts DC refrigerators
- For models DC6843 - 12/24 Volts DC refrigerators
- For models DC6844 - 12/24 Volts DC refrigerators

Serial No. \_\_\_\_\_

**English**

**French**

NORCOLD, Inc.  
P.O. Box 4248  
Sidney, OH 45365-4248  
Printed in Japan

Norcold Customer Support Dept.  
Telephone: 800-543-1219  
Fax: 937-497-3183  
Web Site: [www.norcold.com](http://www.norcold.com)

**Owner's Manual** ..... 2

Dual Electric Warranty Policy ..... 2

Dual Electric Warranty Information ..... 3

Dual Electric Warranty Questions ..... 3

Safety Awareness ..... 4

Safety Instructions ..... 4

About Your Refrigerator ..... 4

    Storage volume ..... 4

    Food compartment ..... 4

    Freezer compartment ..... 4

Operation ..... 5

    Controls ..... 5

Refrigerator Care Checklist ..... 5

    Defrosting ..... 5

    Cleaning ..... 5

    Door Sealing ..... 6

Refrigerator Maintenance Checklist ..... 6

Troubleshooting ..... 6

    If the refrigerator does not cool correctly ..... 6

    Over heating shut-off device operation ..... 6

    Over current protection system ..... 6

Wiring Pictorial ..... 7

Replacement Parts ..... 7

**Installation Manual** ..... 7

Safety Awareness ..... 7

Safety Instructions ..... 7

Ventilation ..... 8

Connect the 12 Volt DC Supply ..... 8

Install the Refrigerator ..... 8

**NORCOLD - Dual Electric Two Year Limited Warranty Policy**

Norcold, Inc. warrants that when properly installed and placed under normal service and use its refrigeration equipment is free from defects in material and workmanship for two years commencing from the original date of purchase of the new equipment.

**Limitations of Warranty**

1. This Warranty is the only warranty for a Norcold AC/DC refrigerator. This Warranty does not extend to glassware, electric light bulbs, and replaceable fuses.
2. This warranty does not apply to parts and assemblies that have been subjected to misuse, improper installation, abnormal service, transit damage, recharging of cooling system, accident, fire, improper repair, tampering or abuse.
3. Irrespective of the nature of the warranty protection offered or claimed, the period of warranty shall in no case extend beyond two years commencing from the original date of purchase of the new equipment.

**LIMITATION OF REMEDY**

1. **THE RESPONSIBILITY OF NORCOLD UNDER THIS OR ANY WARRANTY IS LIMITED TO THE REPAIR OR REPLACEMENT (AT NORCOLD'S OPTION) OF THE DEFECTIVE PART OR ASSEMBLY.**
2. **IN NO EVENT AND UNDER NO CIRCUMSTANCES SHALL NORCOLD BE RESPONSIBLE UNDER THIS LIMITED WARRANTY FOR ANY OTHER CHARGE WHATSOEVER, INCLUDING BUT NOT LIMITED TO CHARGES OR CLAIMS FOR LABOR, LOST BUSINESS, LOST TIME, LOST PROFITS, LOSS OF USE, OR ANY KIND OF INCIDENTAL OR CONSEQUENTIAL DAMAGES, HOWEVER DENOMINATED OR DESCRIBED. THE REMEDY UNDER THIS WARRANTY IS LIMITED TO REPAIR OR REPLACEMENT.**
3. **SOME STATES DO NOT ALLOW THE EXCLUSION OR LIMITATION OF INCIDENTAL OR CONSEQUENTIAL DAMAGES, SO THE ABOVE EXCLUSION MAY NOT APPLY TO YOU.**

**DISCLAIMER OF OTHER WARRANTIES**

**THIS WARRANTY IS EXPRESSLY IN LIEU OF ALL OTHER WARRANTIES EITHER EXPRESSED OR IMPLIED. ALL OTHER WARRANTIES, EXPRESSED OR IMPLIED, INCLUDING ANY WARRANTY OF MERCHANTABILITY OR FITNESS FOR A PARTICULAR PURPOSE, ARE HEREBY DISCLAIMED AND EXCLUDED.**

**Legal Rights**

This warranty gives you specific legal rights, and you may have other legal rights which vary from state to state.

## Dual Electric Warranty Information

---

Your refrigerator is made to provide the ultimate in cooling satisfaction and will serve you reliably in the years to come. Norcold refrigerators are the only RV refrigerators made in the United States and offer a standard limited two-year warranty.

To activate your two-year limited warranty, complete and mail the warranty registration supplied.

Help us to help you.

Write the model number and serial number below for future reference. These numbers are on a label inside the refrigerator and on the cover of this manual. Use these numbers when receiving service or in any correspondence concerning your refrigerator.

Model number \_\_\_\_\_ Serial number \_\_\_\_\_

If a problem occurs with your refrigerator, contact any of the service centers throughout the United States and Canada. To find an authorized Norcold Service Center near you, please telephone the Norcold Customer Support Dept. at 800-543-1219 (option-1) or visit our web site at [www.norcold.com](http://www.norcold.com).

Norcold is committed to providing products that are in harmony with the environment. Your Norcold refrigerator meets all environmental safety standards.

## Dual Electric Warranty Questions

---

This warranty is the only warranty for your Norcold refrigerator. There are no other express warranties. The only uses for this product are described in this manual. Part or model specifications are subject to change without notice.

### What does this warranty cover?

This warranty covers labor and freight (ground service only) and costs incurred in removing and reinstalling the refrigerator when necessary to replace a defective part and any parts replaced under warranty (including cooling units).

### What is not covered by this warranty?

- Travel expenses for bringing the refrigerator to an authorized Norcold Service Center for warranty coverage.
- Additional costs caused by the inability to bring the refrigerator to an authorized Norcold Service Center.
- Defects which are caused by transit damage, misuse, neglect, or accident.
- Manufacturing defects found at the time of purchase, parts replaced under warranty, and associated labor, which the original consumer-purchaser does not communicate to Norcold within 30 days.
- Labor, performed without need for parts replacements, which the original consumer-purchaser does not communicate to Norcold within 30 days.
- Defects in glassware, electric light bulbs, or replacement fuses.
- Defects caused by improper installation, maintenance, or adjustment.
- Normal maintenance of this refrigerator as described in this manual.
- Defects caused by the improper use of parts or parts not manufactured or supplied by Norcold for repairs or replacements to the refrigerator.

Norcold will not be liable for any incidental or consequential loss or damage, due directly or indirectly to the use of this product. Some states do not allow the exclusion or limitation of incidental or consequential damages, so the above may not apply to you.

### How long does this warranty last?

This warranty is effective for a period of two years from date of purchase.

### What will Norcold do?

Norcold will provide free service and replacement of defective parts, at no charge, at all authorized Norcold Service Centers. Norcold has the option of replacing the defective parts or the entire refrigerator. If the refrigerator is replaced, Norcold is not responsible for replacing dealer installed options.

### How do you get service?

Bring the refrigerator to any authorized Norcold Service Center and show proof that the defective item is within warranty coverage.

If you are unable to bring the refrigerator to an authorized Norcold Service Center:

- Send a written notice of the defect to Norcold.
- Norcold will promptly advise you how to obtain warranty service.

### What rights do you have?

This warranty gives you specific legal rights. You may also have other rights which vary from state to state.

## Safety Awareness

---

Read this manual carefully and understand the contents before you use the refrigerator.

Be aware of possible safety hazards when you see the safety alert symbol on the refrigerator and in this manual. A signal word follows the safety alert symbol and identifies the danger of the hazard. Carefully read the descriptions of these signal words to fully know their meanings. They are for your safety.



**WARNING:** This signal word means a hazard, which if ignored, can cause dangerous personal injury, death, or much property damage.



**CAUTION:** This signal word means a hazard, which if ignored, can cause small personal injury or much property damage.

## Safety Instructions

---



**WARNING:**

- The storage of flammable materials behind or around the refrigerator creates a fire hazard. Do not use the area behind the refrigerator to store anything, especially flammable materials (gasoline, cleaning supplies, etc.)
- A circuit overload can result in an electrical fire if the wires and/or fuses are not the correct size. Use only the wire and fuse sizes as written in the "Installation Manual".
- Incorrect installation, adjustment, change to, or maintenance of this refrigerator can cause personal injury, property damage, or both. Have service and maintenance work done by your dealer or by an authorized Norcold Service Center.
- Disconnect the DC power source before doing any maintenance work on the refrigerator. All service work on this refrigerator must be done by a qualified service technician.
- Do not bypass or change the refrigerator's electrical components or features.
- When you discard an appliance, remove all doors to prevent accidental entrapment and suffocation.
- Do not spray liquids near electrical outlets, connections, or the refrigerator components. Many liquids are electrically conductive and can cause a shock hazard, electrical shorts, and in some cases fire.



**CAUTION:**

- Do not touch the evaporator or other metal parts inside the refrigerator cabinet with wet hands because they can freeze to the refrigerator.
- The rear of the refrigerator has sharp edges and corners. To prevent cuts or abrasions when working on the refrigerator, be careful and wear cut resistant gloves.

## About Your Refrigerator

---

Your refrigerator was thoroughly cleaned before shipment from the factory. It is advisable, however, to clean the interior once more before using. See "Cleaning".

### Storage Volume:

This refrigerator is made to store fresh and frozen foods and for making ice.

DC68XX models	1.5 cubic feet capacity
DC85XX models	1.5 cubic feet capacity
DC39XX models	3.2 cubic feet capacity
DC73XX models	3.2 cubic feet capacity

### Food compartment:

Start up the refrigerator and let it cool for eight hours before loading with food. If the refrigerator does not start to cool down after about two hours, contact your dealer or an authorized Norcold Service Center.

For the best cooling performance:

- Let air move freely inside the entire food compartment.
- Do not cover the shelves with plastic, paper, etc.

To decrease the amount of ice that collects on the freezer plates:

- Cover all liquids and moist foods.
- Let all hot foods cool before putting them in the refrigerator.
- Do not open the door any longer than necessary.

### Freezer compartment:

The freezer compartment is made to keep pre-frozen food frozen and not to quick freeze food. Keep pre-frozen foods in the freezer compartment.

**NOTE:** When making ice, put the ice cube tray directly on the freezer surface. Do not put other items on the ice cube tray while the water is freezing. The water freezes more rapidly if the power switch / thermostat is at the coldest temperature setting.

## Operation

### Controls:

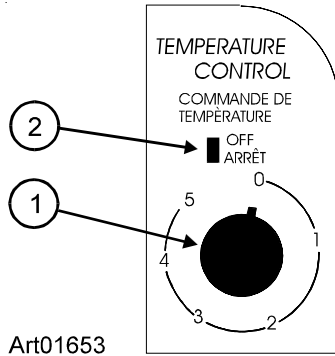

This refrigerator is made for refrigerating purposes and operates on a 12/24 volt DC power supply when installed as written in this manual.

On DC68XX and DC85XX models, the controls are located in the right-hand upper rear corner of the food compartment of the refrigerator.

On DC39XX and DC73XX models, the controls are located inside the freezer door on the right-hand side of the freezer compartment.

The refrigerator temperature is controlled by a thermostat [1], located on the panel above the door. A green power light [2], located on the panel comes on when the refrigerator is "ON". Number "1" is the warmest and number "5" is the coldest thermostat position. For efficient operation, change the thermostat according to the types of food stored and the ambient temperature.

**CAUTION:** Do not operate the refrigerator when the ambient temperature is higher than 110° F. Operation at this temperature will start the over heating shut-off device. See "Over heating shut-off device operation".

## Refrigerator Care Checklist

Your refrigerator will give you years of trouble free service if you do these simple checks every three to six months:

- Defrost the refrigerator as necessary. See "Defrosting".
- Keep the food compartment and the freezer clean. See "Cleaning".
- Make sure the door seals correctly. See "Door sealing".
- Be aware of any cooling changes that are not because of weather, loading, or thermostat changes. If changes occur, contact your dealer or an authorized Norcold Service Center.

- Make sure the air flow in the lower intake vent, through the refrigerator condenser and coils and out the upper exhaust vent is not blocked or decreased.
- Make sure the area behind the refrigerator is clear. Do not use the area behind the refrigerator for storage of anything, especially combustible materials, especially gasoline and other flammable vapors and liquids.

### Defrosting:

It is normal for frost to collect on the freezer plates of the refrigerator. Excess frost decreases the cooling performance of the refrigerator. Defrost the refrigerator as necessary:

- Put the power switch / thermostat in the OFF position.
- Remove all food from the refrigerator.

**NOTE:** Defrosting the refrigerator makes excess water inside the refrigerator.

- Put dry towels (etc.) inside the refrigerator to absorb the water.
- Put trays of hot water in the freezer until the frost is melted.
- Empty the drip tray in either of these two ways:
  - Pull the drip tray forward to remove it from the refrigerator.
  - Remove the drain plug from the drip tray and allow the water to flow into another container.
- Remove the wet towels (etc.) and dry the interior.
- If removed, put the drip tray in the refrigerator.
- Put all food in the refrigerator.
- Put the power switch / thermostat at the temperature setting that you wish.

### Cleaning:

A good time to clean the refrigerator is just after you defrost it.

Clean the inside of the refrigerator as often as necessary to avoid food odors:

- Remove all food from the refrigerator.

**NOTE: Do not use abrasive cleaners, chemicals, or scouring pads because they can damage the interior of the refrigerator.**

- Wash the interior with a mild cleaner or a solution of liquid dish detergent and warm water.
- Rinse with a solution of baking soda and clean water.

- Dry with a clean cloth.
- Put all food into the refrigerator.

### Door sealing:

If the door does not seal correctly, excess frost will collect inside the refrigerator. Make sure the door seals correctly:

- Close the door on a piece of paper that is about the size of a dollar bill (See Art00980).
- Gently pull the paper.
  - You should feel a slight drag between the gasket and the cabinet.
  - Do this on all four sides of the door.
  - If you do not feel a slight drag on the paper, the door is not sealing correctly.
  - Have your dealer or an authorized Norcold Service Center correct the seal of the door

## Refrigerator Maintenance Checklist

If you are not going to use the refrigerator for an extended period of time, put the thermostat to the "OFF" position.

**NOTE: Norcold is not responsible for installation, adjustment, alteration, service, or maintenance performed by anyone other than a qualified RV dealer or an authorized Norcold Service Center.**

Have a qualified RV dealer or an authorized Norcold Service Center do these annual safety and maintenance checks:

- Make sure the DC voltage is 10.2 - 30.5 volts.
- The wire connections must be clean, tight and free of corrosion. If any of these items are not correct:
  - A voltage drop to the refrigerator will occur.
  - The voltage drop will decrease the cooling performance of the refrigerator.



**CAUTION:** Disconnect the positive (+) DC power supply wire from the battery before you do a "fast charge" of the battery. Failure to disconnect the positive (+) power supply wire from the battery during a "fast charge" can cause damage to the refrigerator or other 12 volt DC appliances.

- Make sure the area at the rear of the refrigerator is free of anything, especially combustible materials, gasoline, and other flammable vapors and liquids.

## Troubleshooting

### If the refrigerator does not cool correctly:

- Make sure the power switch / thermostat is not in the OFF position.
- Make sure that the refrigerator is correctly installed and that the vents are not blocked.
- Make sure that the power source to the refrigerator is serviceable.
- Make sure that the fuse or circuit breaker is intact (See "Over current protection system" section).
- Make sure that the ambient temperature is not unusually high (more than 110° F. / 43° C.) (See "Over heating shut-off device operation" section).
- Make sure that the door is closed.
- If the weather is hot, make sure that the door is sealing correctly.
- Make sure that the air circulation inside the refrigerator is not decreased by foods or by shelves that are covered with plastic, paper, etc.
- Make sure that hot foods were not placed in the fresh food compartment of the refrigerator.
- Make sure that the freezer is defrosted.

After you make these checks, if the refrigerator does not operate, contact your dealer or an authorized Norcold Service Center.

### Over heating shut-off device operation:

Operating the refrigerator in high ambient temperatures can over heat the cooling unit and cause premature failure of the compressor. (See the label inside the refrigerator.)

To protect the cooling unit from over heating, the refrigerator will automatically shut-off when the vehicle air temperature is higher than 110° F. If shut off occurs, an audible alarm tone (an intermittent beeping) operates from the refrigerator.

To stop the audible alarm tone and restart the refrigerator, turn the thermostat counterclockwise to the "OFF" position and then clockwise to the desired thermostat position.

The refrigerator will not restart until the air temperature is lower than 110° F.

## Over current protection system:

Your refrigerator has an over current protection system in the electronic circuit to prevent damage to the inverter which may occur due to a reverse polarity connection.

If the refrigerator does not operate and the green power light does not come on, check the fuse, which is located in-line with the DC connector, and the polarity of the DC power supply. If the refrigerator still does not operate, another problem can exist in the inverter. Have an authorized Norcold Service Center check the refrigerator.

## Wiring Pictorial

The parts of the wiring pictorial are (Art01264):

Battery In + .....	1
Battery In - .....	2
Fuse .....	3
Fan 24V DC .....	4
DC / DC Converter .....	5
Inverter .....	6
Condenser Coupling .....	7
Electronic Current Protector .....	8
Ambient Thermistor .....	9
Evaporator Thermistor .....	10
Input High Voltage Protector .....	11
High Temperature Protector Buzzer (optional) .....	12
Low Temperature Protector .....	13
Battery Monitor .....	14
Electronic Thermostat .....	15

## Replacement Parts

You may purchase replacement parts through your dealer or an authorized Norcold Service Center.

# Installation Manual

## Safety Awareness

Read this manual carefully and understand the contents before you install the refrigerator.

Be aware of possible safety hazards when you see the safety alert symbol on the refrigerator and in this manual. A signal word follows the safety alert symbol and identifies the danger of the hazard. Carefully read the descriptions of these signal words to fully know their meanings. They are for your safety.



**WARNING:** This signal word means a hazard, which if ignored, can cause dangerous personal injury, death, or much property damage.



**CAUTION:** This signal word means a hazard, which if ignored, can cause small personal injury or much property damage.

## Safety Instructions



**WARNING:**

- For installations which need an electric outlet that is energized by an external power source, the refrigerator must be electrically grounded as written in local codes or the National Electrical code, NFPA 70.
- Incorrect installation, adjustment, alteration, or maintenance of this refrigerator can cause personal injury, property damage, or both.
- Do not bypass or change the refrigerator's electrical components or features.
- Protect all wiring from physical damage, vibration, and excessive heat.
- Do not spray liquids near electrical outlets, connections, or the refrigerator components. Many liquids are electrically conductive and can cause a shock hazard, electrical shorts, and in some cases fire.



**CAUTION:**

- The rear of the refrigerator has sharp edges and corners. To prevent cuts or abrasions when working on the refrigerator, use caution and wear cut resistant gloves.

## Ventilation

This refrigerator is made for a built-in installation. Correct ventilation is necessary for the correct operation of the refrigerator and to increase the life of the refrigerator cooling system.

Correct ventilation allows the natural air flow that is necessary for good refrigeration. Cooler air comes in through a lower intake vent, goes around the refrigerator coils where it removes the excess heat from the refrigerator components, and goes out through a side exhaust vent. If this air flow is blocked or decreased, the refrigerator will not cool correctly.

The refrigerator has a fan which will operate only when the ambient temperature is higher than approximately 95° F.

 **CAUTION:** The refrigerator has built in vents on the right and left sides. Make sure that the flow of air through these vents is not blocked in any way. Blockage of air through these vents can cause:

- shortened life of the refrigerator cooling unit.
- poor cooling performance of the refrigerator.
- continuous operation of the refrigerator.
- fast battery discharge.
- void of the refrigerator warranty.

## Connect the 12 Volt DC Supply

This refrigerator operates on 12/24 volts DC current from a battery.

 **CAUTION:** Only connect the refrigerator directly to the battery. Because they often generate high voltage pulses and cause transistor defects in the inverter, no other switches, lead wires, or electrical equipment should share the wiring between the refrigerator and battery.

When using either a converter or a battery charger, make sure that they are connected in parallel between the battery and the refrigerator. Do not use a converter or battery charger to supply the DC power directly to the refrigerator because these two devices do not supply filtered DC power (See Art01521).

Correct .....	1
Incorrect .....	2
Refrigerator .....	3
Battery charger or AC/DC converter, etc. ....	4
Transistorized DC power supply .....	5
Condenser .....	6
Battery .....	7

As the distance from the vehicle battery to the refrigerator increases, the correct AWG wire size also increases. If the wire size is too small for the distance, a voltage drop occurs. The voltage drop decreases the cooling performance of the refrigerator.

1. Norcold recommends that you use the following wire and fuse sizes:

- Measure the distance from the vehicle battery to the refrigerator:
  - If the distance is less than 12 feet, use 16 AWG wire and a 10 Amp fuse.
  - If the distance is between 12 and 20 feet, use 14 AWG wire and a 10 Amp fuse.
  - If the distance is more than 20 feet, use 12 AWG wire and a 10 Amp fuse.
- Twist the lead wires to reduce the radio interference and induction of a high voltage surge from the outside (See Art01518).

Correct .....	1
Incorrect .....	2
Refrigerator .....	3
Battery .....	4
Electrical equipment .....	5
Twisted lead wires .....	6

NOTE: This wiring is already in the vehicle. It is located behind the wall trim panel.

2. Push the DC connector of the refrigerator completely into the DC plug of the vehicle.

## Install the Refrigerator

The refrigerator should be installed only on a solid surface in the vehicle.

1. Align the mounting rails on the bottom of the refrigerator [1] with the mounting rails on the bottom of the refrigerator enclosure [2] (See Art01652).
2. Carefully push the refrigerator completely into the enclosure.
3. Open the door of the refrigerator.
4. Align the hole in the mounting rail on the bottom of the refrigerator and the hole in the mounting rail on the bottom of the refrigerator enclosure.
5. Put the mounting screw down through the opening [3] in the bottom trim of the refrigerator (See Art01651).

 **CAUTION:** Make sure that the mounting screw is not cross-threaded in the mounting flanges. Cross-threading will damage the mounting flange and/or the screw.

6. Turn the mounting screw down into the mounting rails.
7. Tighten the mounting screw.



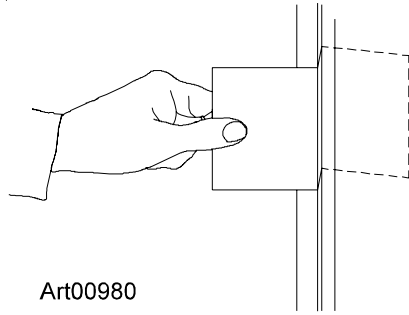

Art00980

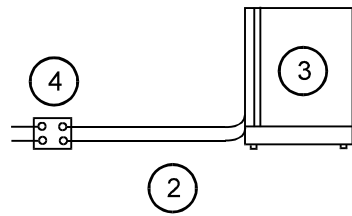

2

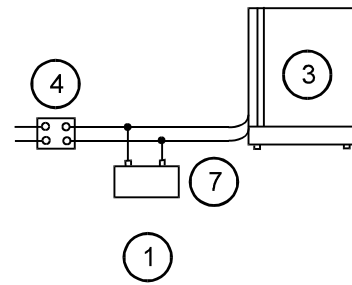

1

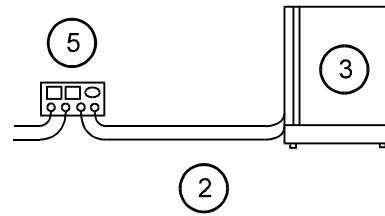

2

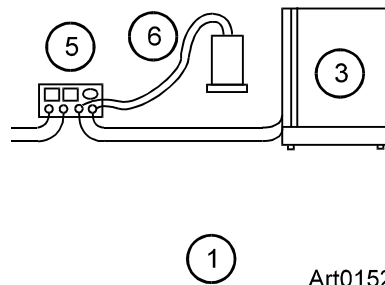

1

Art01521

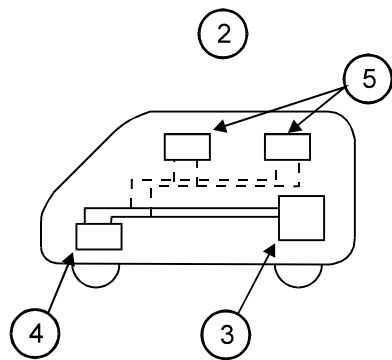

Art01518

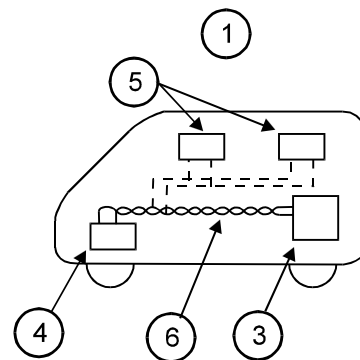

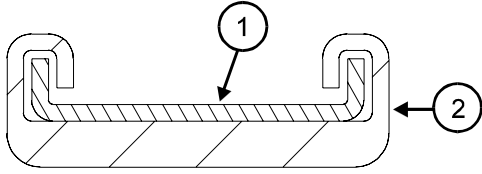

Art01652

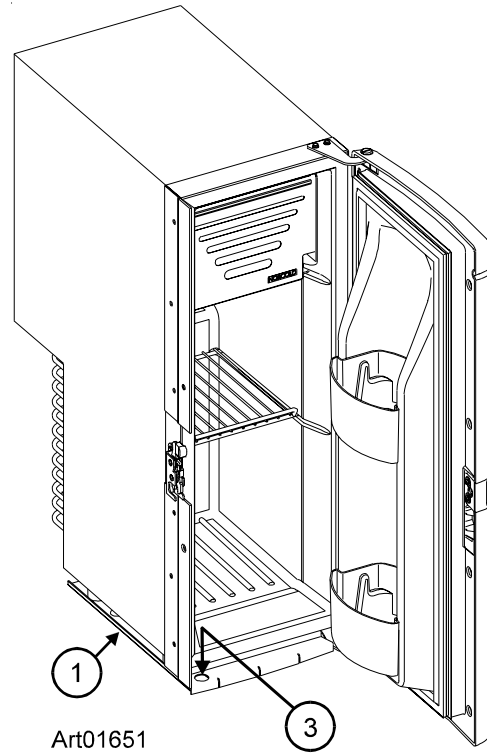

Art01651

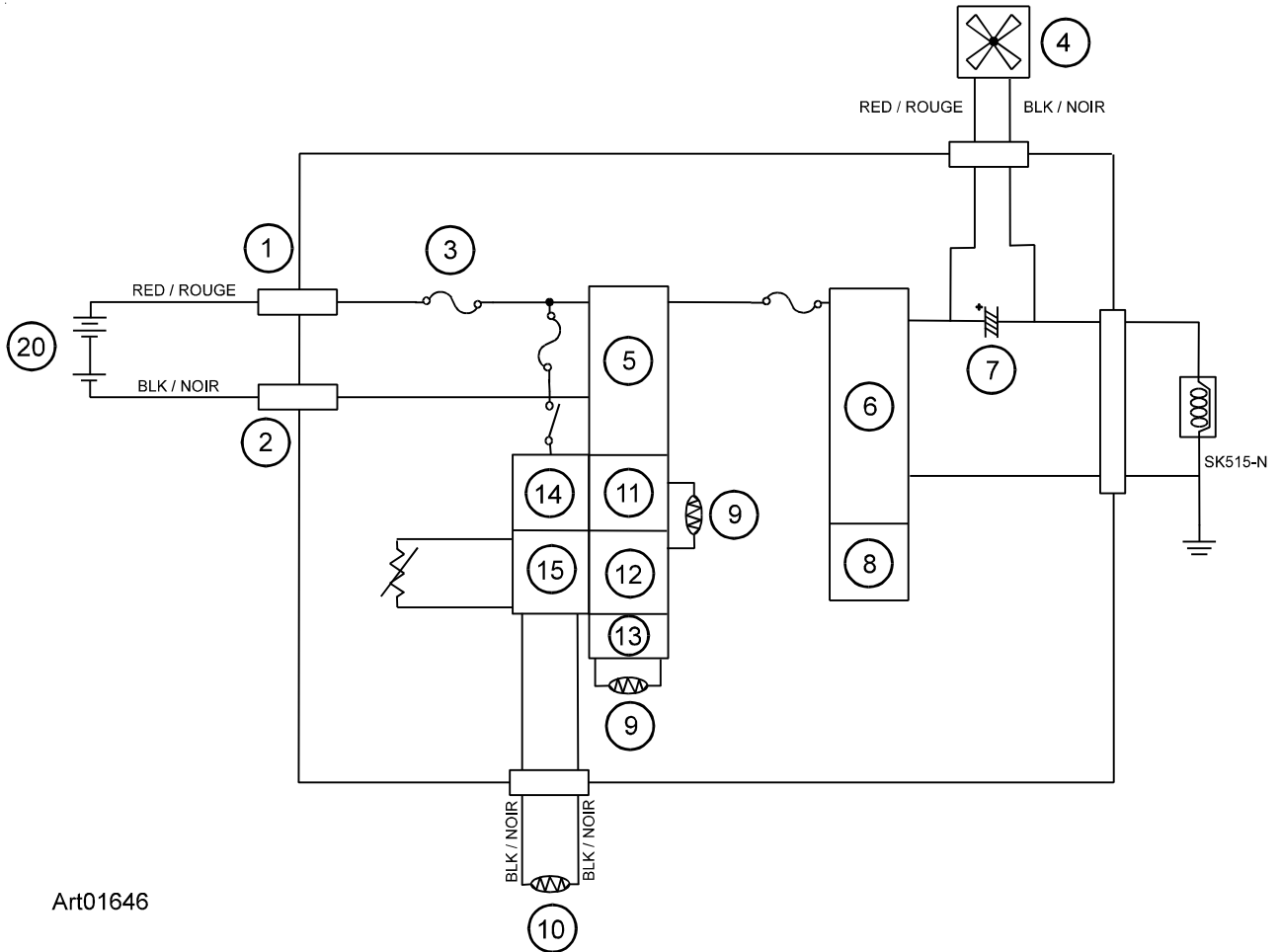

Art01646